



### **PARALLELE CON BASAMENTO 260308**

Istruzioni per il montaggio e l'installazione che devono essere seguite per l'utilizzo corretto delle parallele 260308.



### **BARRES PARALLELES AVEC SOCLE: 260308**

Instructions à suivre impérativement pour l'assemblage, l'installation et l'emploi correcte des barres parallèles 260308.



### **PARALLEL BARS WITH PLATFORM: 260308**

It is imperative to follow the instructions below to assure correct assembly, installation as well as correct use of the parallel bars 260308.







### **GEHBARREN MIT SCHRITTFÜHRUNG: 260308**

Bitte befolgen sie die montageanleitung genau, um eine sachgerechte montage, installation und verwendung des gehbarren zu gewährleisten.





-  **Leggere le istruzioni e utilizzare il prodotto come indicato in base alla sua funzione.**
-  **Lire les instructions et utiliser le produit conformément à sa fonction.**
-  **Read the instructions and use the product as directed according to its function.**
-  **Bitte lesen Sie die Anleitungen aufmerksam durch und verwenden Sie das Produkt nur seinem Zweck entsprechend.**

## **Indice - Index - Index - Index**

Istruzioni per l'assemblaggio - Notice d'assemblage Instruction for the assembly - Montageanleitung.....	p. 6
Targhetta di identificazione - Plaque d'identification Identification label - Identifizierungsschild.....	p.17
Avvertenza di sicurezza - Notice de sécurité Warnings - Sicherheitswarnung.....	p.18
Classificazione ed uso - Classification et utilisation Classification and use - Klassifikation und nutzung .....	p.19
Scheda tecnica - Fiche technique - Data sheet - Datenblatt .....	p.21
Portata del dispositivo - Capacité de charge de l'appareil Carrying capacity of the device - Tragfähigkeit des Gerätes .....	p.22
Dichiarazione di conformità - Declaration de conformité Declaration of conformity - Konformitätserklärung.....	p.23

# FERROX®

Physiotherapy Quality Solutions





2/3



1/3

3/3



2/3

TOT. : 3

1/3



3/3



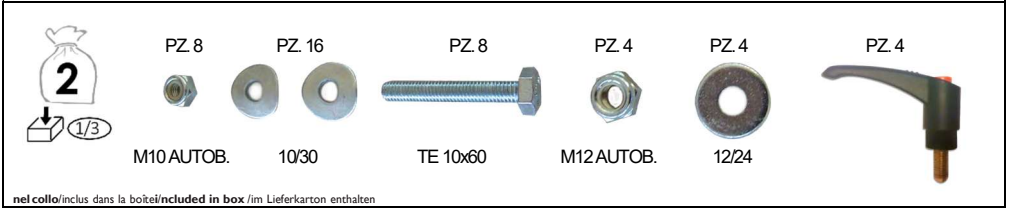
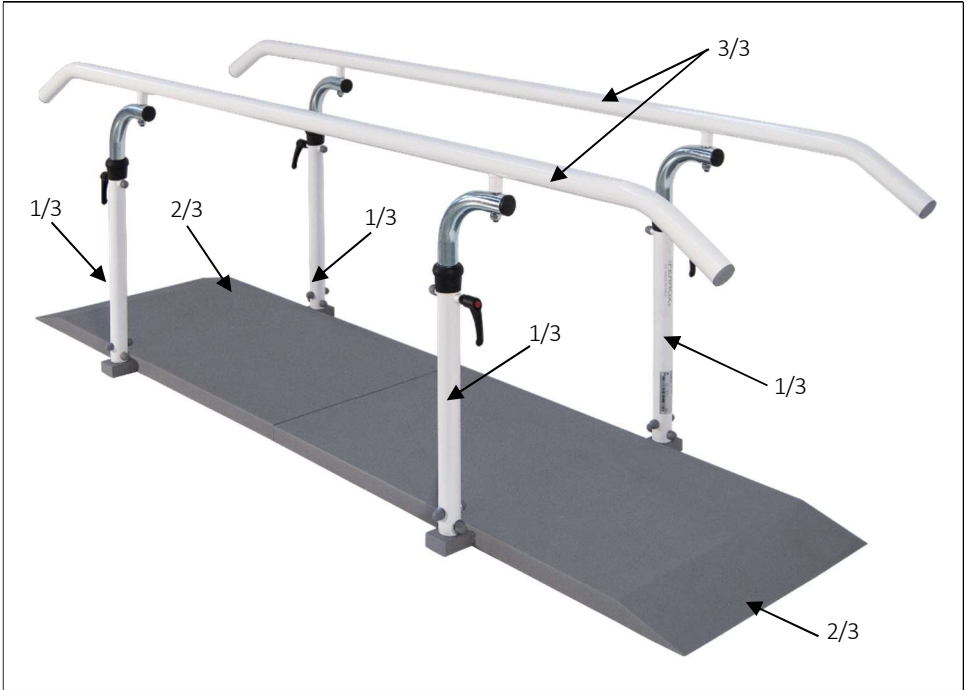

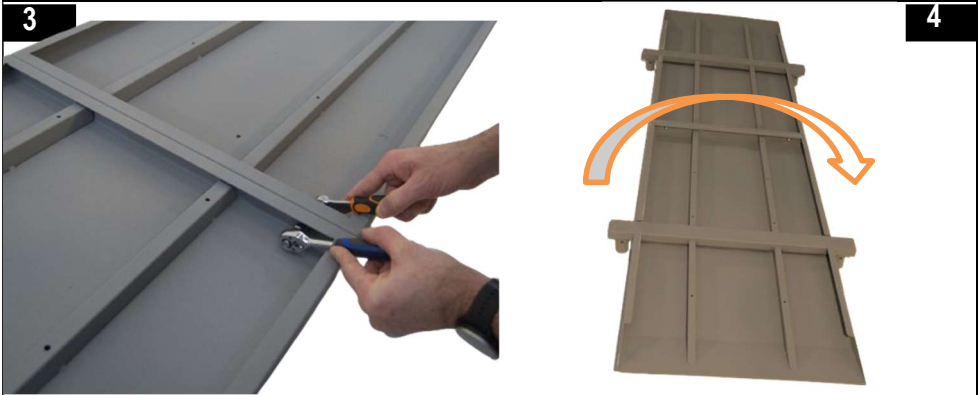
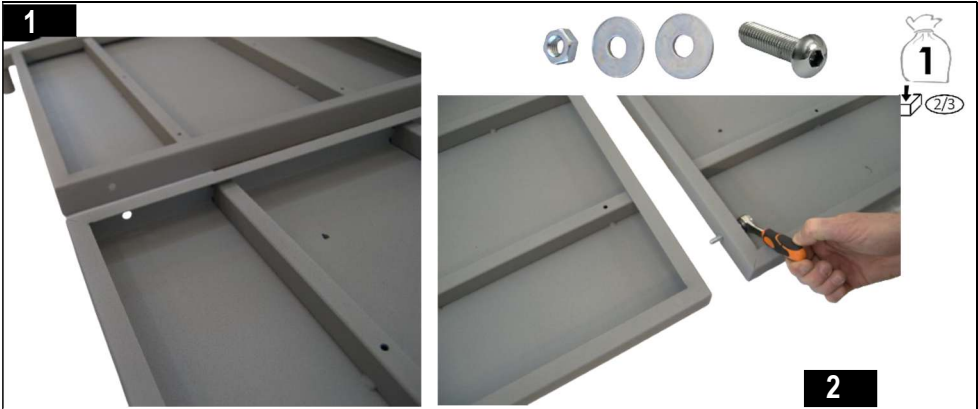

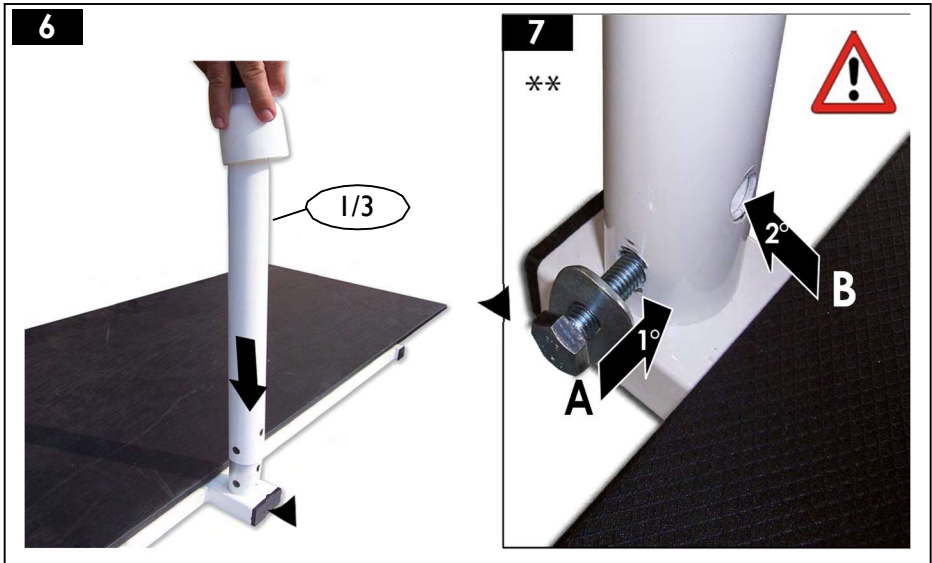

- UNIRE IL SUPPORTO BIANCO ALL'APPOSITO ANCORAGGIO SUL PIANO DI CAMMINAMENTO
- FIXER LE TUBE DE SOUTIEN BLANC, CYLINDRIQUE, À SON SUPPORT SUR LE SOCLE,
- INSERT THE WHITE CYLINDRICAL SUPPORT TUBE INTO THE DESIGNATED FITTING ON THE BASE
- BEFESTIGEN SIE DIE WEIßE ZYLINDERFÖRMIGE ROHRSTÜTZE AN DER VORGEGEHEHENEN BEFESTIGUNG AM SOCKEL

**ATTENZIONE: PER IL CORRETTO FISSAGGIO È INDISPENSABILE INIZIARE IL FISSAGGIO, A PARTIRE DAL FORO PIÙ IN BASSO**

**ATTENTION: POUR L'INSTALLATION CORRECTE IL EST INDISPENSABLE DE COMMENCER L'INSTALLATION A' PARTIR DU TROU PLUS BAS (A)**

**NOTE: TO ENSURE CORRECT ASSEMBLY OF THE ITEM IT IS NECESSARY TO START AT THE BOTTOM HOLE AND PROCEED FROM THERE UPWARDS**

**ACHTUNG : FÜR EINE ORDNUNGSGEMÄßE INSTALLATION IST ES NOTWENDIG DIE INSTALLATION VOM UNTERSTEN LOCH HER ZU BEGINNE**

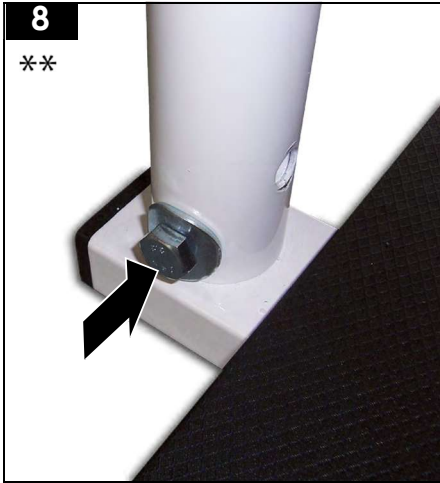

- INSERIRE IL PERNO FILETTATO CON **RONDELLA CONCAVA** ALL'INTERNO DEL FORO **PIÙ IN BASSO (A)**
- FAIRE PASSER LA VIS AVEC SA **RONDELLA CONCAVE** À L'INTÉRIEUR DU TROU **PLUS BAS (A)**
- INSERT THE SCREW WITH ITS **CONCAVE WASHER** INTO THE **BOTTOM HOLE (A)**
- FÜHREN SIE DIE SCHRAUBE MIT SEINER **KONKAVEN UNTERLEGSCHIBE** IN DAS **UNTERSTE LOCH** EIN (A)

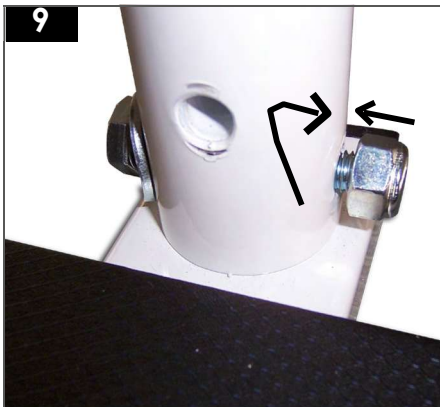

- **AVVITARE IL DADO FINO IN FONDO** PER CONSENTIRE ALLA **RONDELLA CONCAVA** DI ADATTARSI ALLA SUPERFICIE
- **VISSER L'ÉCROU LE PLUS POSSIBLE** POUR QUE LA **RONDELLA CONCAVE** SOIT AJUSTÉ À LA SURFACE DU TUBE
- **FASTEN THE NUT WELL** SO THAT THE **CONCAVE WASHER** SITS TIGHTLY ON THE SURFACE OF THE TUBE
- **ZIEHEN SIE DIE MUTTER GUT FEST**, SODASS DIE **KONKAVE UNTERLEGSCHIBE** AUF DER OBERFLÄCHE DES ROHRES FEST AUFLIEGT

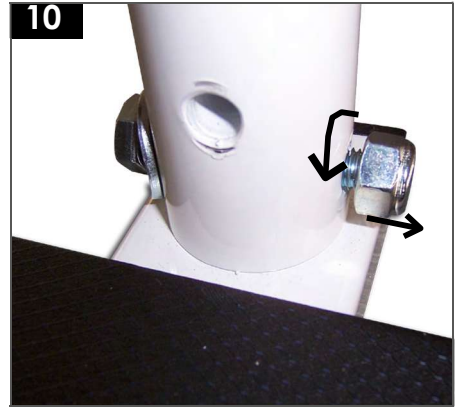

- **ESTRARRE NUOVAMENTE IL DADO**
- **ENLEVER L'ÉCROU DE NOUVEAU**
- **UNSCREW THE NUT AGAIN**
- **SCHRAUBEN SIE DIE MUTTER WIEDER AB**

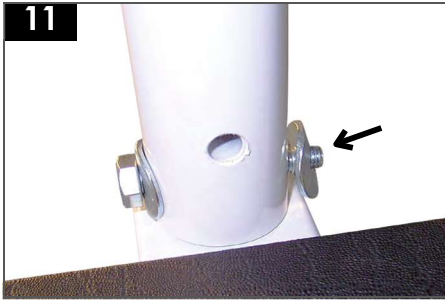

- INSERIRE L'ALTRA RONDELLA CONCAVA A LATO OPPOSTO
- METTRE L'AUTRE RONDELLE CONCAVE SUR LE CÔTÉ OPPOSÉ
- FIT ANOTHER CONCAVE WASHER TO THE OPPOSITE SIDE
- SETZEN EINE WEITERE KONKAVE UNTERLEGSCHLEIBE AUF DER GEGENÜBERLIEGENDEN SEITE AUF

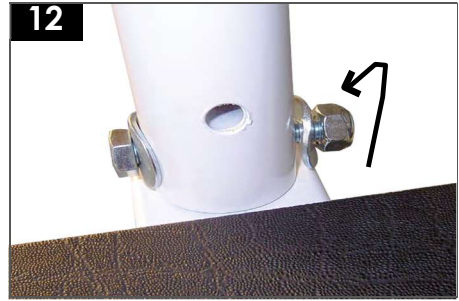

- RIMETTERE IL DADO ED AVVITARE FINO ALLA PERFETTA CHIUSURA
- REMETTRE L'ÉCROU ET VISSER JUSQU'À SA PARFAITE FERMETURE
- PUT THE NUT ON THE SCREW AGAIN AND TIGHTEN AS FAR AS IT WILL GO
- SETZEN SIE DIE MUTTER WIEDER AUF UND SCHRAUBEN SIE DIESE BIS ZUM ANSCHLAG FEST



- RIPETERE LE OPERAZIONI PRECEDENTI ANCHE PER I PERNI SUPERIORI
- RÉPÉTER LES ÉTAPES DE TRAVAIL POUR LES VIS SUPÉRIEURS
- REPEAT THE PROCEDURE FOR THE UPPER SCREWS
- WIEDERHOLEN SIE DIE ARBEITSSCHRITTE FÜR DIE OBEREN SCHRAUBEN

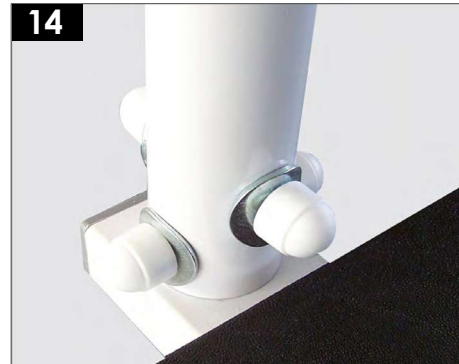

- COMPLETARE L'OPERAZIONE APPLICANDO I COPRIDADO IN DOTAZIONE
- POUR COMPLÉTER L'INSTALLATION, METTRE LES CACHES BLANCHES LIVRÉES AVEC
- TO FINISH, FIT THE WHITE COVERINGS INCLUDED IN DELIVERY
- MONTIEREN SIE ZUM ABSCHLUSS DIE IM LIEFERUMFANG ENTHALTENEN WEIßEN ABDECKUNGEN



15

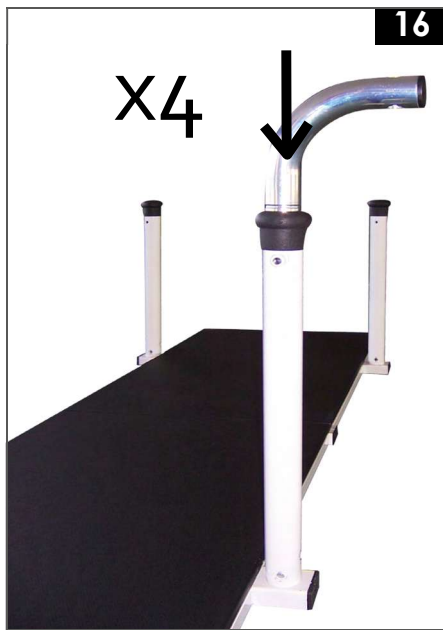

16

- 15**
- EQUINDI SU TUTTI I QUATTRO SUPPORTI DEI CORRIMANO
  - SUIVRE LA MÊME PROCEDURE POUR LE MONTAGE DE TOUS LES TUBES DE SOUTIEN BLANCS
  - PROCEED AS DESCRIBED ABOVE TO ANCHOR ALL OTHER WHITE SUPPORT TUBES
  - GEHEN SIE WIE OBEN BESCHRIEBEN FÜR DIE BEFESTIGUNG ALLER WEIßEN ROHRSTÜTZEN VOR

- 16**
- INSERIRE I QUATTRO TUBI SCORREVOLI NEI LORO SUPPORTI
  - FAIRE GLISSER LES QUATRE TUBES COULISSANTS À L'INTÉRIEUR DES SIX TUBES DE SOUTIEN
  - INSERT ALL SIX SKID PIPES INTO THE FOUR SUPPORT TUBES
  - FÜHREN SIE DIE VIER GLEITROHRE IN DIE SECHS ROHRSTÜTZEN EIN

- 17**
- APPLICARE I BLOCCAGGI DEGLI SCORREVOLI NELL'APPOSITA SEDE
  - APPLIQUER UNE MANETTE DE SERRAGE SUR LE CÔTÉ DE CHAQUE TUBE DE SOUTIEN
  - FIT ONE BOLT LEVER TO THE SIDE OF EACH SUPPORT TUBE
  - BRINGEN SIE JEWEILS EINEN SPANNHEBEL AUF DER SEITE EINER ROHRSTÜTZE AN

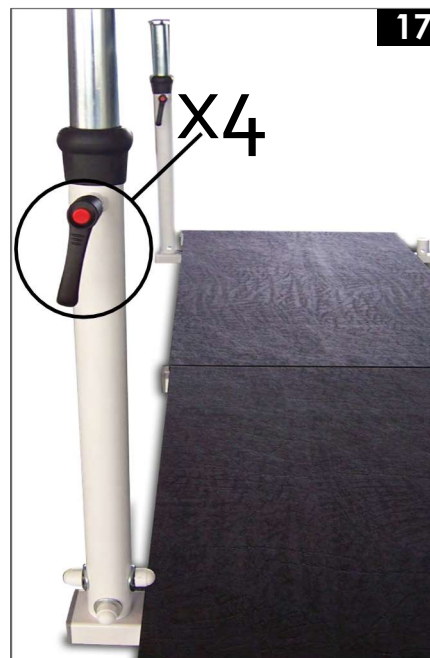

17



APRIRE - OUVRI  
OPEN - ÖFFNEN

CHIUDERE - FERMER  
CLOSE - SCHLIESSEN

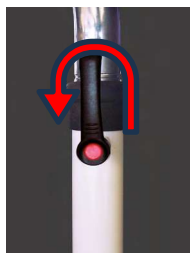

- POSIZIONE DELLA LEVA DA RISPETTARE PER APRIRE/CHIUDERE
- POSITION DE LA MANETTE EN POSITION OUVERT/FERME'
- OPEN / CLOSED POSITIONS OF THE BOLT LEVER
- POSITIONEN DES SPANNHEBELS OFFEN / GESCHLOSSEN



NO/NON  
NO/NEIN



NO/NON  
NO/NEIN



SI/OUI  
YES/JA



- POSIZIONE CORRETTA CHE LA LEVA DEVE AVERE DOPO AVERE BLOCCATO GLI SCORREVOLI
- POSITION CORRECTE QUE LA MANETTE DOIT OCCUPER POUR BLOQUER LES TUBES COULISSANTS
- CORRECT POSITION OF THE BOLT LEVER TO LOCK THE SKID PIPE IN PLACE
- RICHTIGE POSITION DES SPANNHEBELS UM DIE GLEITROHRE ZU ARRETIEREN

18



3/3

- PRELEVARE I CORRIMANO DAL LORO IMBALLO
- ENLEVER L'EMBALLAGE DES MAINS COURANTES
- REMOVE THE PACKAGING MATERIAL FROM THE HANDRAILS
- ENTFERNEN SIE DAS VERPACKUNGSMATERIAL VON DEN HANDLÄUFEN

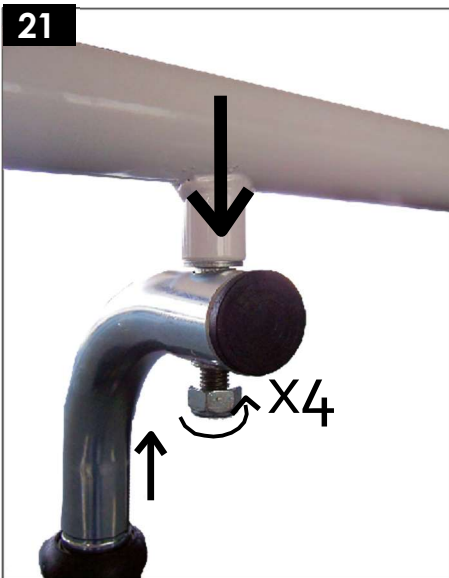
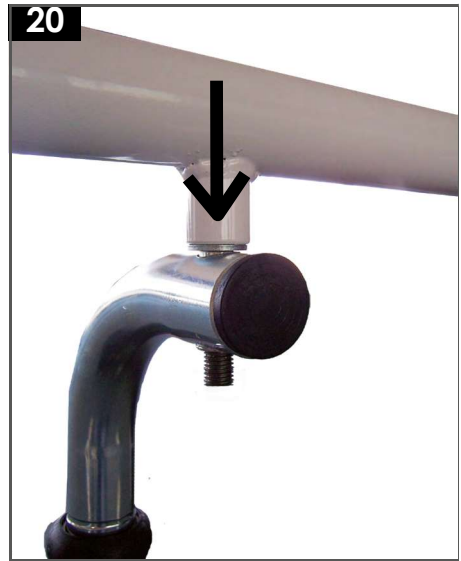
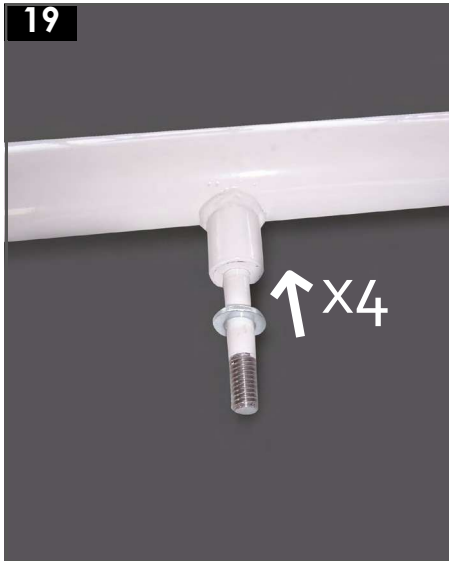

- ASSICURARE I DUE CORRIAMANO NELLE APPOSITE SEDI MEDIANTE I DADI FORNITI ALLO SCOPO
- FIXER LES DEUX MAINS COURANTES DANS LEUR SIÈGE AU MOYEN DES ECREUS LIVRÉS AVEC.
- FIX BOTH HANDRAILS IN THE INTENDED POSITION USING THE NUTS INCLUDED IN DELIVERY
- BEFESTIGEN SIE DIE BEIDEN HANDLÄUFE IN DER VORGEGEHEHENEN POSITION MITHILFE DER IM LIEFERUMFANG ENTHALTENEN SCHAUBMUTTERN



## INSTALLAZIONE DEL CORRIMANO

## INSTALLATION BARRES PARALLELES

## ASSEMBLY OF PARALLEL BARS

## MONTAGE DER GEHBARREN

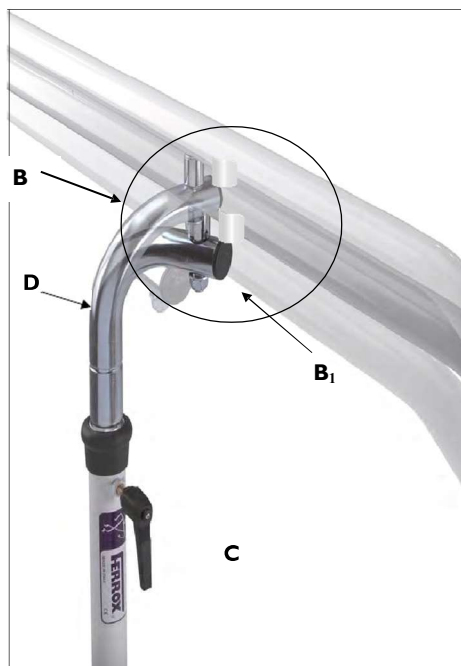

- SCOPO DELL'INSIEME (B) È L'ANCORAGGIO DEL CORRIMANO AL SUPPORTO SCORREVOLE (D). IL DADO (B1) DEVE ESSERE CHIUSO **SENZA**, TUTTAVIA, IMPEDIRE LA ROTAZIONE DEL CORRIMANO PER LA REGOLAZIONE IN LARGHEZZA. LA REGOLAZIONE DELLA LARGHEZZA SI EFFETTUA ALLENTANDO LA LEVA (C) E SPINGENDO, PER ACCOMPAGNARLO (VERSO DESTRA O SINISTRA), IL SUPPORTO CROMATO (D).
- LE BUT DE L'ENSEMBLE (B) EST DE FIXER LA MAIN COURANTE A' SON APPUI. L'ÉCROU (B1) DOIT ÊTRE SERRE' **SANS**, TOUT DE MÊME EMPÊCHER LA ROTATION DE LA MAIN COURANTE POUR SON RÉGLAGE EN LARGEUR. LE RÉGLAGE DE LA LARGEUR EST FAIT EN DESSERRANT LE LEVIER (C) ET EN POUSSANT (VERS DROITE OU GAUCHE) LE SUPPORT CHROME' (D).
- THE ASSEMBLED PARTS (B) PROVIDE FOR THE FIXATION OF THE HANDRAIL TO ITS SUPPORTING STAND. SCREW-NUT (B1) HAS TO BE TIGHTENED **WITHOUT** IMPEDING THE ROTATION OF THE HANDRAIL, TO ALLOW FOR ITS ADJUSTMENT IN BREADTH. FOR ADJUSTMENT IN BREADTH, RELEASE LEVER (C) AND GENTLY PUSH AND TURN (TO THE LEFT/RIGHT) CHROMED SUPPORT (D).
- ZUSAMMENSTELLUNG (B) SOLL DIE BEFESTIGUNG DES HANDLAUFS AM STÄNDER GEWÄHRLEISTEN. SCHRAUBENMUTTER (B<sub>1</sub>) MUSS FESTGEZOGEN SEIN, OHNE DIE ROTATION ZUR BREITENVERSTELLUNG DES HANDLAUFS ZU VERHINDERN. FÜR DIE BREITENVERSTELLUNG WIRD HEBEL (C) GELÖST UND DIE VERCHROMTE STÜTZE (D) DURCH LEICHTE STOßBEWEGUNGEN (NACH RECHTS ODER LINKS) GEDREHT.



## INSTALLAZIONE DEL CORRIMANO - INSTALLATION BARRES PARALLELES ASSEMBLY OF PARALLEL BARS - MONTAGE DER GEHBARREN

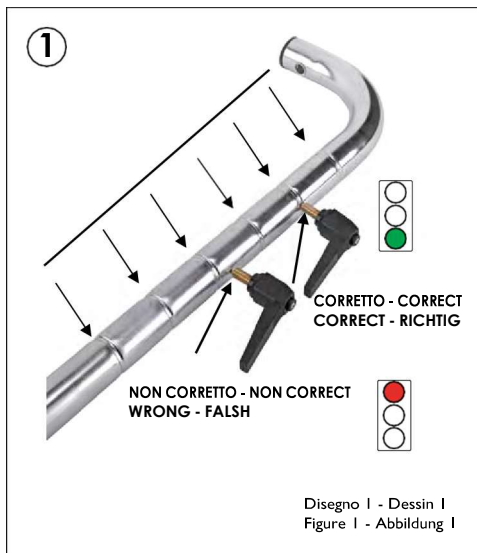

L'ALTEZZA DEL CORRIMANO È REGOLATA CORRETTAMENTE, E MESSA IN SICUREZZA, UNICAMENTE QUANDO LA LEVA DI CHIUSURA SI TROVA ALL'INTERNO DEL SOLCO DI FISSAGGIO.

LA HAUTEUR DE LA BARRE PARALLÈLE EST FIXÉE CORRECTEMENT, ET SÉCURISÉE, UNIQUEMENT LORSQUE LE LEVIER DE SERRAGE SE TROUVE A L'INTÉRIEUR DU CRAN (ENCOCHE) D'ARRÊT.

THE HEIGHT OF THE PARALLEL BARS IS CORRECTLY AND SECURELY ADJUSTED, ONCE THE FASTENER TIGHTLY SITS IN ONE OF THE SPECIFICALLY DESIGNED NOTCHES.

DIE HÖHE DES GEHBARRENS IST NUR DANN RICHTIG UND SICHER EINGESTELLT, WENN DER KOPF DES SPANNHEBELS 1 DER VORGESEHENEN KERBE SITZT.

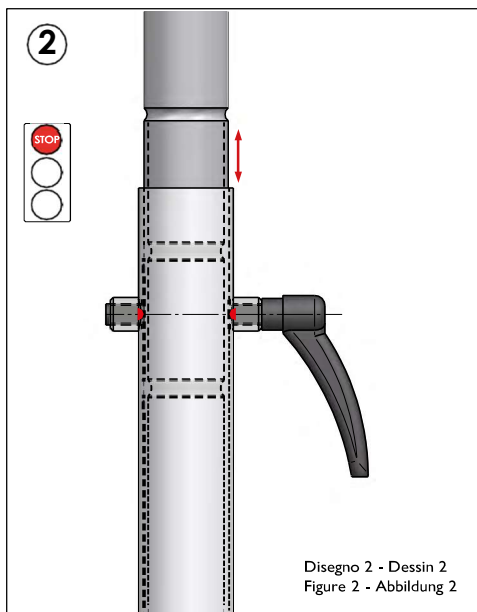

QUESTA POSIZIONE DI FISSAGGIO:  
**NON È CORRETTA**

VEDERE IL DISEGNO 3 PER LA POSIZIONE CORRETTA.

CETTE POSITION DE FIXATION N'EST:  
**PAS CORRECTE.**  
VOIR DESSIN 3 POUR LA BONNE  
FIXATION

THE NOTCH POSITIONING FOR HEIGHT ADJUSTMENT IS: **WRONG.**  
REFER TO FIGURE 3 FOR CORRECT  
ALIGNMENT.

DIESE BEFESTIGUNG DER  
HÖHENEINSTELLUNG IST: **FALSCH.** SIEHE  
ABBILDUNG 3 FÜR DIE RICHTIGE  
EINSTELLUNG.

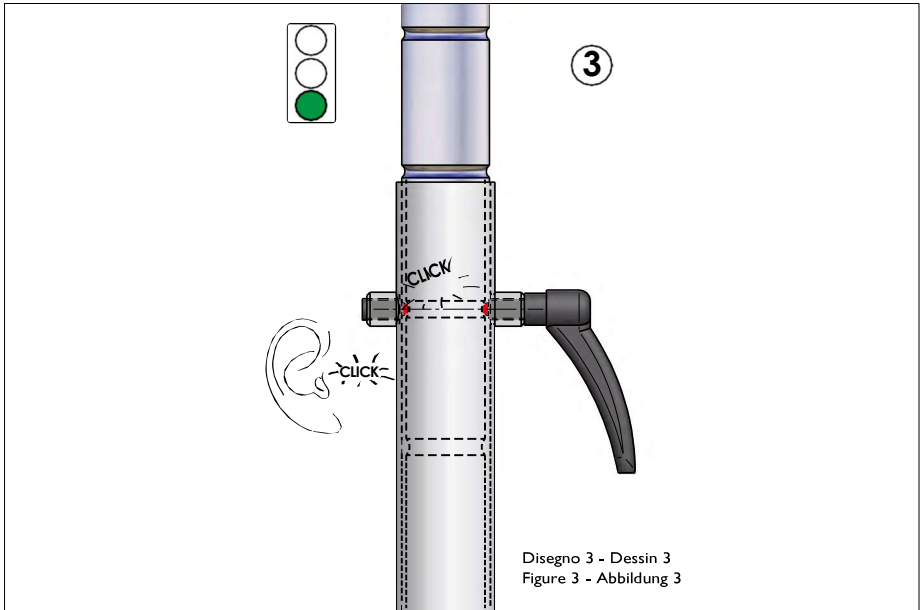

QUESTA POSIZIONE (LIVELLO) DI FISSAGGIO: È **CORRETTA**.

IN QUESTA POSIZIONE, LA LEVA (A) SI TROVA NELLA BUONA CONDIZIONE PER POSIZIONARSI ALL'INTERNO DEL SOLCO DI ARRESTO INFERIORE

CETTE POSITION (NIVEAU) DE FIXATION: **EST CORRECTE**.

EN CETTE POSITION LE LEVIER (A) SE TROUVE DANS LA BONNE CONDITION POUR SE POSITIONNER A' L'INTÉRIEUR DU CRAN D'ARRÊT INFÉRIEUR.

THE NOTCH POSITIONING FOR HEIGHT ADJUSTMENT IS: **CORRECT**.

IN THIS ALIGNMENT THE FASTENER (A) IS CORRECTLY POSITIONED TO SNAP IN THE DESIGNATED NOTCH.

DIESE BEFESTIGUNG DER HÖHENEINSTELLUNG IST: **RICHTIG**.

IN DIESER EINSTELLUNG BEFINDET SICH DER HEBEL (A) AUF DER RICHTIGEN HÖHE, UM IN DER VORGESEHENEN KERBE EINRASTEN ZU KÖNNEN.



**22**

- TERMINARE L'ASSEMBLAGGIO RIPETENDO GLI STESSI PASSAGGI ESEGUITI ANCHE PER IL CORRIMANO OPPOSTO
- POUR COMPLÉTER L'INSTALLATION RÉPÉTER LA MÊME PROCÉDURE POUR LA MAIN COURANTE OPPOSÉE
- TO FINISH THE INSTALLATION OF THE PARALLEL BARS, ASSEMBLE THE OPPOSITE HANDRAIL BY REPEATING THE ABOVE PROCEDURE
- UM DIE INSTALLATION ABZUSCHLIEßEN, MONTIEREN SIE DEN GEGENÜBERLIEGENDEN HANDLAUF NACH DER OBEN BESCHRIEBENEN VORGEHENSWEISE

**23**

- ASPETTO CHE AVRÁ ASSUNTO LA PARALLELA DOPO CHE L'ASSEMBLAGGIO DEL CORRIMANO SARÁ STATO ESEGUITO
- VUE DE LA BARRE PARALLELE APRES QUE LES MAINS COURANTES AURONT ÉTÉ CORRECTEMENT INSTALLÉES
- VIEW OF THE PARALLEL BARS WITH THE HANDRAILS CORRECTLY INSTALLED
- ANSICHT DES GEHBARRENS MIT KORREKT INSTALLIERTEN HANDLÄUFEN



TARGHETTA DI IDENTIFICAZIONE - PLAQUE D'IDENTIFICATION - IDENTIFICATION LABEL - IDENTIFIZIERUNGSSCHILD



**FERROX s.r.l.**  
Via del Lavoro, 9 Z.I.  
31013 Codognè (TV) - Italia  
Tel. +39 0438 777099  
Fax +39 0438 777091  
www.ferrox.it - info@ferrox.it









MD MODEL  
REF YYY Y  
SN XXXXXX  
YY/MM/DD  
-  
- nnnn Kg

 **MADE IN ITALY**

UDI  
  
(01)0805347043YYYY(11)YYMMDD(21)XXXXXX  
Rev 02 del 03/20

<b>CH</b>	<b>REP</b>
-----------	------------

**Élite Med Group Sagl**  
Via Luigi Lavizzari 4  
6850 Mendrisio  
Switzerland

 Simbolo o Sigla	 Descrizione	 Description	 Description	Beschreibung
<b>MD</b>	Dispositivo Medico	Dispositif Médical	Medical Device	Dies ist ein Medizinprodukt
<b>REF</b>	Identificativo catalogo	Identifiant catalogue	Catalogue Number	Katalognummer
<b>SN</b>	Numero di serie	Numéro de série	Serial Number	Seriennummer
	Identificazione fabbricante	Identification du fabricant	Manufacturers name	Names des Herstellers
	Data di fabbricazione	Date de fabrication	Date of manufacture	Herstellungsdatum
	Carico di lavoro in sicurezza	Charge de travail en sécurité	Safety work load	Sichere Arbeitslast
	Consultare le istruzioni per l'uso	Consulter le mode d'emploi	Read the manual	Anleitung lesen
<b>CE</b>	Marchio di conformità CE MDR 2017/745	Marque de conformité CE MDR 2017/745	CE mark MDR 2017/745	CE – Kennzeichen MDR 2017/745
<b>UDI</b>	Identificazione unica del dispositivo	Identification Unique des Dispositifs Médicaux	Unique Device identification	Einmalige Produktkennung
<b>CH REP</b>	Mandatario Svizzero	Mandataire Suisse	Swiss Representative	Schweizer Vertreter



**AVVERTENZA DI SICUREZZA  
WARNINGS**



**NOTICE DE SÉCURITÉ  
SICHERHEITSWARNUNG**





## CLASSIFICAZIONE ED USO

### PARALLELE CON BASAMENTO: 260308

Leggere le istruzioni e utilizzare il prodotto come indicato in base alla sua funzione.

Non usare il prodotto in modo diverso dalla sua destinazione d'uso.

#### USO PREVISTO

Parallele con basamento per l'utilizzo continuativo in ambiente ospedaliero presidiato.  
Pazienti immobilizzati per fratture semplici o per persone residenti anche in RSA che necessitano di un punto di appoggio fermo, regolabile in altezza e larghezza, per una maggiore sensazione di sicurezza.

#### TIPO DI PAZIENTE

Adulti che necessitano di recupero della deambulazione o semplicemente per muoversi in sicurezza all'interno di un locale e di un percorso.

#### LUOGO DI USO

Ospedali, Cliniche specializzate, RSA

#### OPERATORI ABILITATI ALL'USO

Tutti gli operatori sanitari, fisioterapisti e settori affini.  
Sono sufficienti le istruzioni fornite al paziente dall'operatore sanitario di riferimento.

#### CONTROINDICAZIONI

Attenersi ai suggerimenti riportati nel manuale per la sicurezza di utilizzo.  
Non adatto all'utilizzo sportivo.

#### ALTRE INDICAZIONI

Il dispositivo non possiede prestazioni essenziali.

**Segnalare qualsiasi incidente grave che si dovesse verificare a causa del dispositivo. La segnalazione va fatta al fabbricante e all'Autorità competente.**

**A fine vita il prodotto va smaltito in conformità alle norme locali e conferito nei centri di raccolta specifici**



## CLASSIFICATION ET UTILISATION

### BARRES PARALLELES AVEC SOCLE: 260308

Lire les instructions et utiliser le produit conformément à sa fonction.

Ne pas se servir du produit de manière contraire à son utilisation prévue.

#### UTILISATION PREVUE

Barres parallèles avec socle, associés pour une utilisation continue en milieu hospitalier surveillé.  
Patients immobilisés par des fractures simples ou pour les personnes en EHPAD ayant besoin d'un point d'appui stable, réglable en hauteur et en largeur, pour se sentir sécurisés.

#### TYPE DE PATIENT

Adultes ayant besoin d'effectuer une rééducation à la marche ou simplement pour se déplacer en toute sécurité dans un endroit et sur un parcours.

#### MILIEU D'UTILISATION

Hôpitaux, Cliniques spécialisés, EHPAD

#### PROFESSIONNELS HABILITES A L'UTILISATION

Tous les professionnels de la santé, les kinésithérapeute et secteurs apparentés.  
Les instructions transmises au patient par le professionnel de santé de référence suffisent.

#### CONTRE-INDICATIONS

Suivre les conseils figurant dans le manuel pour une plus grande sécurité d'utilisation.  
Non adapté à une utilisation sportive.

#### AUTRES INDICATIONS

Le dispositif ne possède pas de prestations essentielles.

**Signaler tout incident grave survenant à cause du dispositif. Le signalement devra être effectué auprès du fabricant et de l'autorité compétente.**

**En fin de vie, le produit doit être éliminé conformément à la réglementation locale et déposé dans des centres de collecte spécifiques.**



## CLASSIFICATION AND USE

### PARALLEL BARS WITH PLATFORM: 260308

Read the instructions and use the product as directed according to its function.

Do not use the product in a way other than its intended purpose.

#### INTENDED USE

Parallel bars with base for continuous use in manned hospital environment.  
Immobilised patients with simple fractures or residents in aged-care facilities, who require a firm support, adjustable in height and width for a greater feeling of security.

#### TYPE OF PATIENT

Adults who need to learn how to walk again or simply to move around safely inside a room and along a path.

#### PLACE OF USE

Hospitals, specialised clinics, aged-care facilities

#### OPERATORS QUALIFIED TO USE THE PRODUCT

All healthcare professionals, physiotherapists, and related industries.

The instructions given to the patient by the healthcare professional.

#### CONTRAINDICATIONS

Follow the safety instructions in user manual.  
Not suitable for sports use.

#### OTHER INDICATIONS

The device does not have essential levels of performance.

**Report all serious incidents that occur due to the device. Report the incident to the manufacturer and the competent authority**

**At the end of its life, the product must be disposed of in accordance with local regulations and taken to specific waste collection facilities.**



## KLASSIFIKATION UND NUTZUNG

### GEHBARREN MIT SCHRITTFÜHRUNG: 260308

Bitte lesen Sie die Anleitungen aufmerksam durch und verwenden Sie das Produkt nur seinem Zweck entsprechend.

Verwenden Sie das Produkt nicht zu anderen als den angegebenen Zwecken.

#### VORGESEHENE VERWENDUNG

Gehtrainer für den Dauereinsatz in einer bemannten Krankenhausumgebung.

Geeignet für Patienten, die aufgrund Frakturen immobilisiert wurden oder sich in einem Rehabilitationszentrum befinden, sowie Patienten, die eine feste Gehstütze benötigen, die für ein höheres Sicherheitsgefühl in Höhe und Breite regulierbar ist.

#### ARTS DES PATIENTEN

Erwachsene, die alleine Gehen oder sich einfach sicher in einem Raum und auf einem Weg Bewegungen wiedererlernen müssen.

#### VERWENDUNGSORT

Krankenhäuser, Fachkliniken, Rehabilitationszentren

#### ZUR VERWENDUNG BERECHTIGT

sämtliche Gesundheitsberufe, Physiotherapeuten und verwandte Berufe, für jede Art von häuslichem Gebrauch.  
Die vom behandelnden Gesundheitspersonal an den Patienten erteilten Anweisungen sind ausreichend.

#### KONTRAINDIKATIONEN

Befolgen Sie die Tipps im Sicherheitshandbuch.  
Nicht für den sportlichen Einsatz geeignet.

#### WEITERE HINWEISE

Das Gerät erbringt keine unverzichtbare Leistung.

**Jeder schwere, durch das Gerät verursachte Unfall muss gemeldet werden. Die Meldung ist an den Hersteller sowie an die zuständige Behörde zu richten.**

**Am Ende seiner Lebensdauer ist das Produkt den örtlichen Vorschriften entsprechend zu entsorgen und spezifischen Sammelstellen zuzuführen.**

## SCHEDA TECNICA - FICHE TECHNIQUE - DATA SHEET - DATENBLATT



### PARALLELE CON BASAMENTO 260308

**Dimensioni:** 250 X 36 Δ 87 X 78 Δ 104 cm

**Peso:** 57,5 kg

**Conservazione:** luogo asciutto, al buio, -20°+60°

**Modalità di pulizia:** generalmente si consiglia la pulizia del dispositivo dopo ogni utilizzo, eseguire ciclo di disinfezione periodicamente. Per la pulizia del dispositivo è necessario pulire le sue parti mediante un panno inumidito con acqua calda. Attenzione a non usare agenti che danneggino mediante abrasione o un'azione troppo aggressiva la superficie del dispositivo.

**Temperatura d'utilizzo:** 0° / +40°

**Vita presunta:** anni 10, è la stima del periodo in cui il dispositivo potrà essere utilizzato.

È obbligatorio l'uso di guanti monouso e calzature con suola in gomma pulita protette da copri calzatura.



### BARRES PARALLELES AVEC SOCLE: 260308

**Dimensions:** 250 X 36 Δ 87 X 78 Δ 104 cm

**Poids:** 57,5 kg

**Conservation:** dans un lieu sec et à l'abri de la lumière, entre -20 °C et +60 °C

**Nettoyage :** il est généralement conseillé de nettoyer le dispositif après chaque utilisation et d'exécuter périodiquement un cycle de désinfection. Le dispositif doit être nettoyé au moyen d'un chiffon imbibé d'eau chaude. Veiller à ne pas utiliser de produits qui endommageraient la surface du dispositif en raison d'une abrasion ou d'une action trop agressive.

**Température d'utilisation:** 0 °C / +40 °C

**Durée de vie prévue:** 10 ans (estimation de la période pendant laquelle le dispositif pourra être utilisé).

Il est obligatoire pour l'utilisateur et le patient, d'utiliser des gants à usage unique et des chaussures avec une semelle en caoutchouc propre et protégées de couvre-chaussures.



### PARALLEL BARS WITH PLATFORM: 260308

**Dimensions:** 250 X 36 Δ 87 X 78 Δ 104 cm

**Weight:** 57,5 kg

**Storage:** dry, dark place, -20°+60°

**Cleaning:** it is generally recommended to clean the device after each use and to carry out the disinfection cycle periodically. To clean the device, wipe its parts with a cloth moistened with warm water. Do not use any agents that could damage the surface of the device through abrasion or overly aggressive treatment.

**Operating temperature:** 0° / +40°

**Expected lifetime:** it is estimated that the device can be used for 10 years.

It is mandatory for the user and the patient to use disposable gloves and shoes with clean rubber soles with disposable overshoes



### GEHBARREN MIT SCHRITTFÜHRUNG: 260308

**Abmessungen:** 250 X 36 Δ 87 X 78 Δ 104 cm

**Gewicht:** 57,5 kg

**Lagerung:** Trocken und dunkel, Temperatur -20° / +60°

**Reinigung:** Das Gerät sollte generell nach jedem Gebrauch gereinigt werden, und periodisch ist ein Desinfektionszyklus auszuführen. Zur Reinigung alle Teile mit einem mit warmem Wasser befeuchteten Tuch säubern. Beachte: Keine Substanzen verwenden, welche die Geräteoberfläche durch Abrieb oder eine zu aggressive Wirkung beschädigen können.

**Betriebstemperatur:** 0° / +40°

**Erwartete Lebensdauer:** Der Zeitraum, über den das Gerät verwendet werden kann, wird auf 10 Jahre geschätzt.

Der Anwender und Patient müssen Einweghandschuhe und Schuhe mit sauberen Gumminsohlen sowie Einweg Überschuhe tragen.



PORTATA DEL DISPOSITIVO  
CARRYING CAPACITY OF THE DEVICE



CAPACITÉ DE CHARGE DE L'APPAREIL  
TRAGFÄHIGKEIT DES GERÄTES

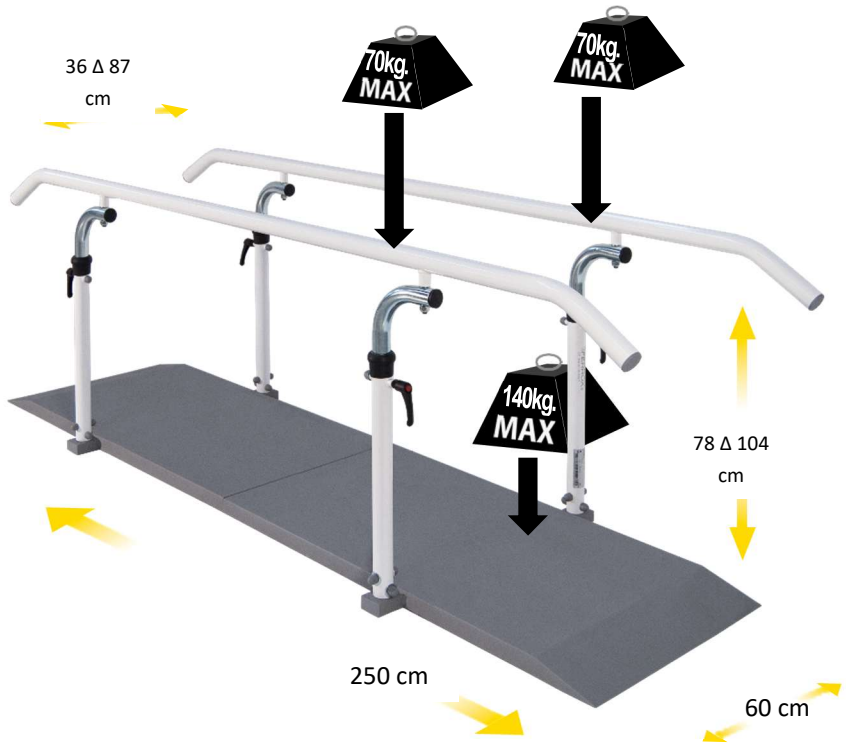



**DICHIARAZIONE DI CONFORMITÀ UE**  
**MDR 2017/745**



**Élite Med Group Sgl**

Via Luigi Lavizzari 4  
6850 Mendrisio  
Switzerland

Fabbricante:

**FERROX S.r.l.**

Via del Lavoro, 9 Z. I. – 31013 Codogné (TV) - ITALIA

+39 0438 777099 – +39 0438 777091

C. F. - P. IVA - R. I. IT 03613220262



[info@ferrox.it](mailto:info@ferrox.it)

**SRN: IT-MF-000011243**

Dichiara sotto la propria totale e completa responsabilità che i prodotti:

Nome	Codice	UDI-DI di Base:
PARALLELA MODULARE DA 250 CM.	260308	805347043PARALLELAD2

soddisfano i requisiti generali di sicurezza e prestazione previsti dall'Allegato I e alle prescrizioni del  
REGOLAMENTO (UE) 2017/745 DEL PARLAMENTO EUROPEO E DEL CONSIGLIO del 5 aprile 2017.

Classificazione (Allegato VIII, MDR 2017/745) :

Classe I (Regola 1)

Procedura di valutazione della Conformità

**Documentazione tecnica come da allegati II e III.**

Data: 02/05/2025

Responsabile FERROX s.r.l.

Firma:



**DECLARATION DE CONFORMITÉ UE**  
**MDR 2017/745**



**Élite Med Group Sagl**

Via Luigi Lavizzari 4  
6850 Mendrisio  
Switzerland

Le fabricant:

**FERROX S.r.l.**

Via del Lavoro, 9 Z. I. - 31013 Codogné (TV) - ITALIA

+39 0438 777099 - +39 0438 777091

C. F. - P. IVA - R. I. IT 03613220262



[info@ferrox.it](mailto:info@ferrox.it)

**SRN: IT-MF-000011243**

Déclare sous sa propre et complète responsabilité que les produits:

Dénomination	Code	UDI-DI Basic:
BARRES PARALLÈLES AVEC SOCLE 250 CM.	260308	805347043PARALLELAD2

Satisfont les requis essentiels applicables prévues à l'Annexe I, ainsi qu'aux prescriptions du REGLEMENT (UE) 2017/745 DU PARLEMENT EUROPEEN ET DU CONSEIL du 5 avril 2017.

Classification (Annexé VIII, MDR 2017/745) :

Classe I (Règle1)

Procédure d'évaluation de la Conformité

**Documentation technique ainsi qu'il est reporté aux annexés II et III.**

Date: 02/05/2025

Le responsable FERROX s.r.l.

Signature: \_\_\_\_\_



DECLARATION OF CONFORMITY UE  
MDR 2017/745



**Élite Med Group Sagi**

Via Luigi Lavizzari 4  
6850 Mendrisio  
Switzerland

Manufacturer:

**FERROX S.r.l.**

Via del Lavoro, 9 Z. I. - 31013 Codogné (TV) - ITALIA

+39 0438 777099 - +39 0438 777091

C. F. - P. IVA - R. I. IT 03613220262



[info@ferrox.it](mailto:info@ferrox.it)

**SRN: IT-MF-000011243**

Under its sole responsibility state that the products:

Name	Code	UDI-DI Basic:
PARALLEL BARS WITH PLATFORM 250 CM.	260308	805347043PARALLELAD2

meet all the applicable essential requirements, of Annex I, implemented by the  
(UE) REGULATION 2017/745 OF THE EUROPEAN PARLAMENT AND COUNCIL on Apr 5 th 2017.

Classified (Annex VIII, MDR 2017/745):

Class I (Rule 1)

Procedure for the assessment of conformity:

**Technical documentation as per annex II and III.**

Date: 02/05/2025

Responsible FERROX s.r.l.

Signature: \_\_\_\_\_



# KONFORMITÄTSERKLÄRUNG UE MDR 2017/745



**Élite Med Group Sagl**

Via Luigi Lavizzari 4  
6850 Mendrisio  
Switzerland

Hersteller:

**FERROX S.r.l.**

Via del Lavoro, 9 Z. I. - 31013 Codogné (TV) - ITALIA

+39 0438 777099 - +39 0438 777091

C. F. - P. IVA - R. I. IT 03613220262



[info@ferrox.it](mailto:info@ferrox.it)

**SRN: IT-MF-000011243**

Erklärt in alleiniger Verantwortung, dass die Produkte:

Name	Code	UDI-DI Basic:
GEHBARREN MIT SCHRITTFÜHRUNG 250 CM.	260308	805347043PARALLELAD2

alle anwendbaren Grundlegende Sicherheits- und Leistungsanforderungen im Sinne von Anhang I der Verordnung (EU) 2017/745 des EUROPÄISCHEN PARLAMENTS UND DES RATES vom 5. April 2017 über Medizinprodukte erfüllen.

Klassifiziert (Anhang VIII, MDR 2017/745):

Klasse I (Regel 1)

Verfahren zur Bewertung der Konformität:

**Technische Unterlagen gemäß Anhang II und III.**

Datum: 02/05/2025

Verantwortlicher FERROX s.r.l.

Unterschrift: 



# FERROX®

Physiotherapy Quality Solutions



Management System  
ISO 13485:2016  
ISO 9001:2015



www.tuv.com  
ID 9000004946

Stabilimento e sede legale:  
via del Lavoro Z.I.  
31013 Codogné (TV) Italia  
Tel. +39 0438 777099 - 778370  
Fax +39 0438 777091  
P.IVA: IT 03613220262

e-mail: [info@ferrox.it](mailto:info@ferrox.it)  
[www.ferrox.it](http://www.ferrox.it)