

**A Assembly instruction “System”**  
**System 1 + Element 8**  
**Art.-No. 4591-30 + Art.-No. 4591-30-8**  
(Version: Steel posts)



## Contents

<b>A</b>	<b>Assembly instruction “System” System 1 + Element 8        Art.-No. 4591-30 + Art.-No. 4591-30-8 (Version: Steel posts)</b> .....	<b>1</b>
<b>1</b>	<b>Introduction Assembling</b> .....	<b>3</b>
<b>2</b>	<b>Datasheet System1 + Element; Art. 4591-30 + Art. 4591-30-8</b> .....	<b>4</b>
<b>3</b>	<b>Delivery contents (parts list with part numbers)</b> .....	<b>5</b>
<b>4</b>	<b>Erection instructions</b> .....	<b>8</b>
<b>5</b>	<b>Post installation checks</b> .....	<b>13</b>
<b>B</b>	<b>Maintenance instruction “System” System 1 + Element 8        Art.-No. 4591-30 + Art.-No. 4591-30-8 (Version: Steel posts)</b> .....	<b>15</b>
<b>6</b>	<b>Introduction Maintenance</b> .....	<b>16</b>
<b>7</b>	<b>General maintenance information</b> .....	<b>17</b>
<b>8</b>	<b>Regular maintenance</b> .....	<b>19</b>
<b>9</b>	<b>Maintenance timetable</b> .....	<b>21</b>
<b>10</b>	<b>Monthly maintenance</b> .....	<b>22</b>
<b>11</b>	<b>Quarterly maintenance</b> .....	<b>22</b>
<b>12</b>	<b>Half yearly maintenance</b> .....	<b>22</b>
<b>13</b>	<b>Annual maintenance</b> .....	<b>23</b>
<b>14</b>	<b>Maintenance printout</b> .....	<b>25</b>
<b>15</b>	<b>Hand over document</b> .....	<b>27</b>

## List of Tables

Table 3-1: Delivery contents, in words .....	5
Table 3-2: Delivery contents, in symbols.....	6

## 1 Introduction Assembling

### 1.1 General information

This equipment should be installed, inspected, maintained and operated in accordance with EN1176-7 guidelines.

**Before installation work commences, please check that you have all of the equipment and fixation components in the parts list provided (see Tables 3-1 and 3-2).**

Any spare parts that may be required can be obtained directly from your supplier.

Please do not hesitate to call us on **01308 425100** if you have any problems during installation or with any other questions.



**Attention**

Following installation, complete assembly instructions, maintenance instructions and a maintenance record must be sent to the operator who must confirm receipt in writing. See the last page of this document.



**Attention**

All nuts and bolts are hot-dip galvanised or stainless steel. One of the characteristics of stainless steel is that uncontrolled cold welding may occur when the nuts are tightened. To prevent this, it is necessary to spray the nuts and bolts with Teflon spray or another similar lubricant.

**We hereby confirm that this play equipment has been tested and certified in accordance with the play equipment standard EN 1176.**

## 2 Datasheet System1 + Element; Art. 4591-30 + Art. 4591-30-8

1. Space requirement including safety area: 7.30 m x 7.30 m  
Height of fall: 1.50 m

The images (individual drawings) are not to scale!!

2. Required safety surface:

Surface material	Description mm	Minimum thickness of layer mm	Maximum height of fall mm
Topsoil grass			<= 1000*
Chipped bark	20 – 80 grain size	300/400	<= 2000/3000
Wood chippings	5 – 30 grain size	300/400	<= 2000/3000
Sand	0.2 – 2 grain size	300/400	<= 2000/3000
Gravel	2 – 8 grain size	300/400	<= 2000/3000
Other ground materials	As recommended by manufacturer		

3. Name and overall dimension of the largest component  
5 steel posts; length 3.00 m,  $\varnothing$  102 mm
4. Intended age group: 2 years and over
5. **Please note that this equipment is set in concrete.**  
Concrete: C25/30  
Required concrete: 0.80 m<sup>3</sup>  
Foundations/area to be excavated:  
**5 x 0.60 m long x 0.60 m wide, total depth 0.80 m including 10 cm drainage**  
**5 x 0.60 m long x 0.60 m wide x 0.50 high, top edge of concrete rounded.**  
(Top edge of concrete 30 cm below play level)  
Fall protection area: at least 33.4 m<sup>2</sup>
6. Assembly time, once foundations complete: 1 2 hours.  
Required assistance: 2 people.
7. Any spare parts which may be required can be obtained directly from your supplier
8. **We hereby confirm that this item of play equipment has been tested and certified in accordance with the play equipment standard EN 1176.**

### 3 Delivery contents (parts list with part numbers)


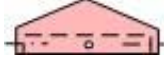



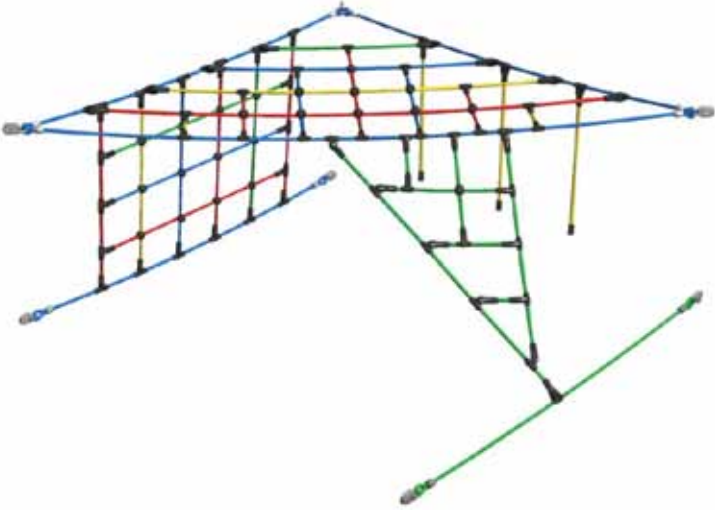

#### 3.1 In words




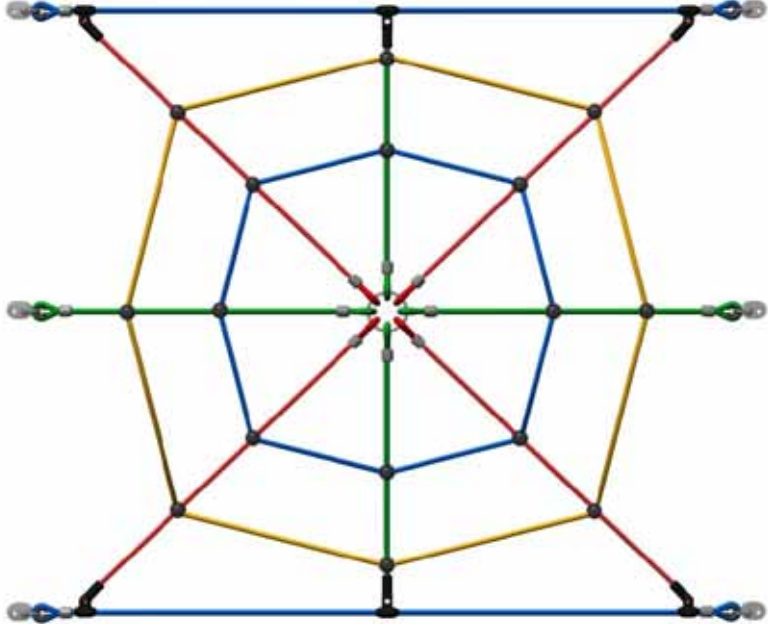

Table 3-1: Delivery contents, in words

Pos.	Quantity	Element / Description	Size	O.K.	Missing
1	5	Steel posts	Ø 102 mm, length 3.00 m		
2	5	Red synthetic cover caps	for Ø 102 mm		
3	27	Pipe clips with carriage bolts and stop nuts	M10 x 35 mm lg.		
4	15	Self tapping screws	4.8 x 25 mm		
5	1	Red paint (1 tin) + brush			
6	1	<b>(Element 1) 4591-30-1</b> Platform net with transversal climber)			
6a	1	Part of <b>Element 1</b> Triangular hanging ladder			
7	(1)	<b>(Element 2) 4591-30-2</b> Climbing net pre-assembled at pos. 6			
8	1	<b>(Element 3) 4591-30-3</b> Balancing rope			
9	1	<b>(Element 4) 4591-30-4</b> Rubber hammock			
10	2	Handrail			
11	1	Spidernet			
12	5	Pipe clips with threaded bolts M10 x 150 mm + 2 nuts			

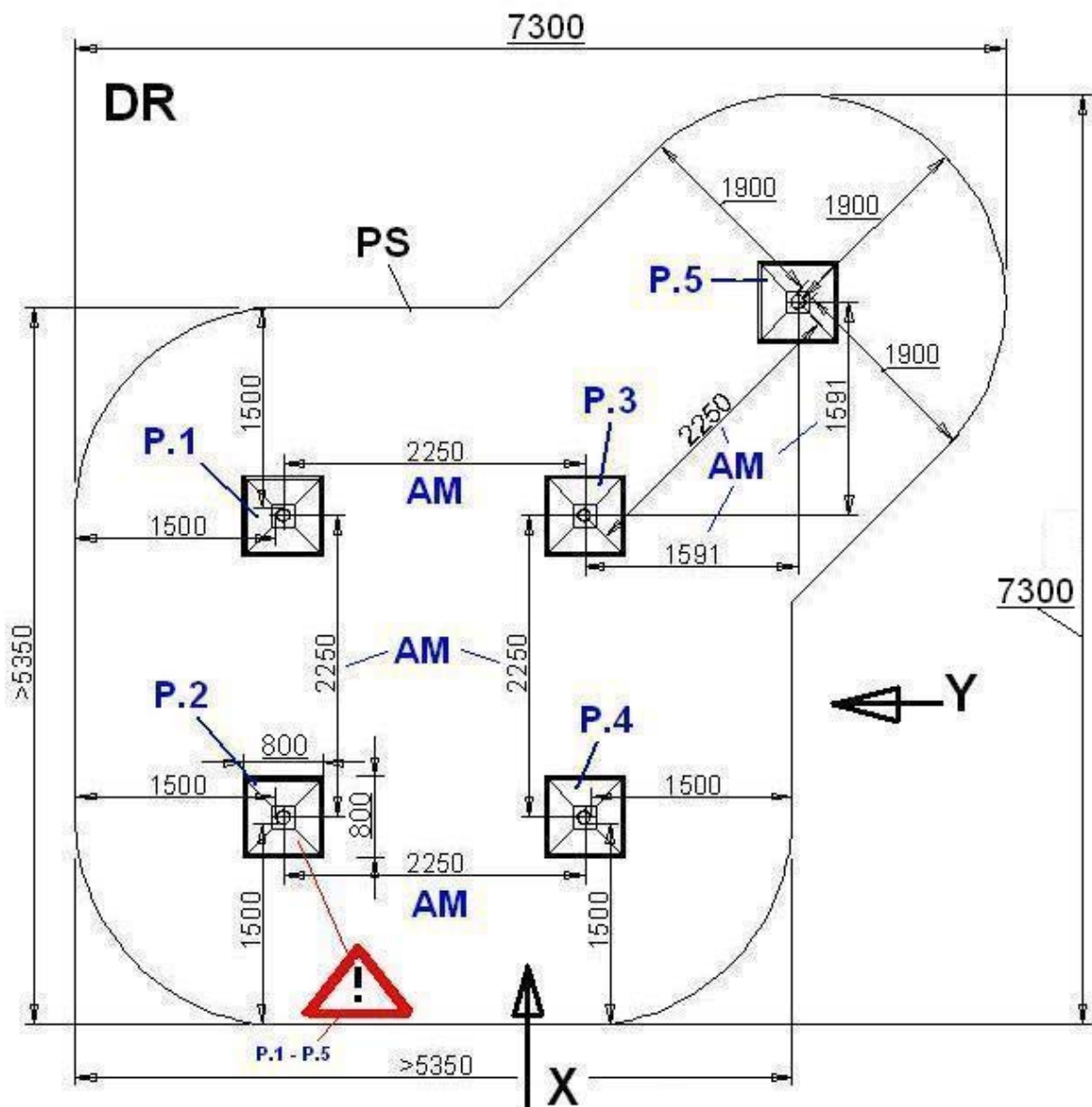
### 3.2 In symbols

Table 3-2: Delivery contents, in symbols

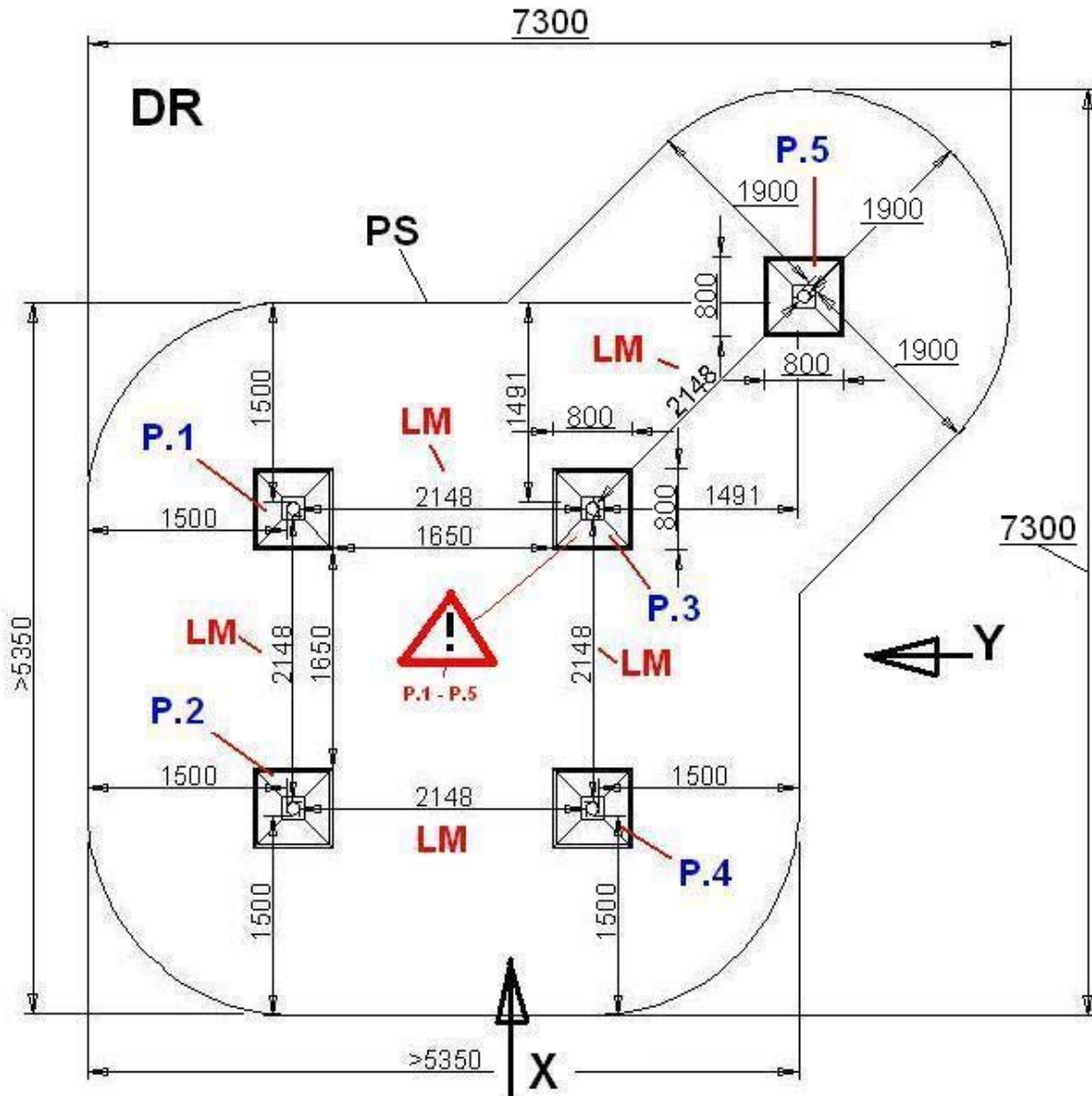
Pos.	Quantity	Symbol
1	5	
2	5	
3	27	
4	15	
5	1	
6	1	
6a	1	
7	(1)	<u>Pre-assembled at Pos. 6</u>

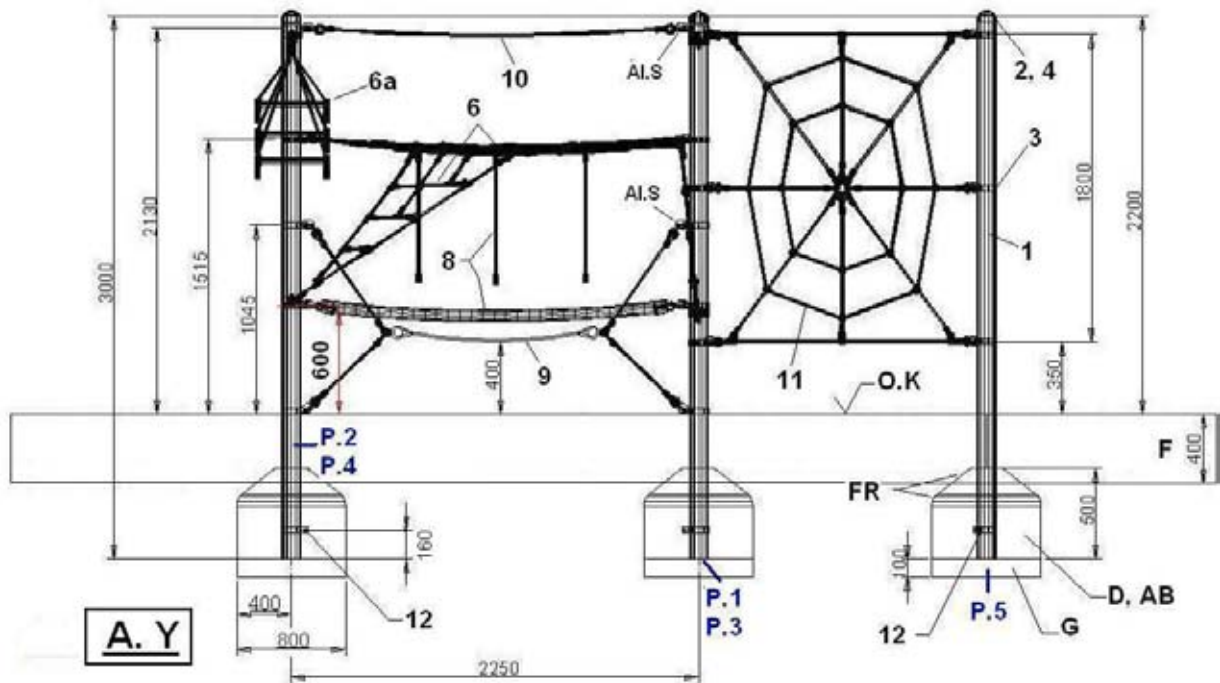
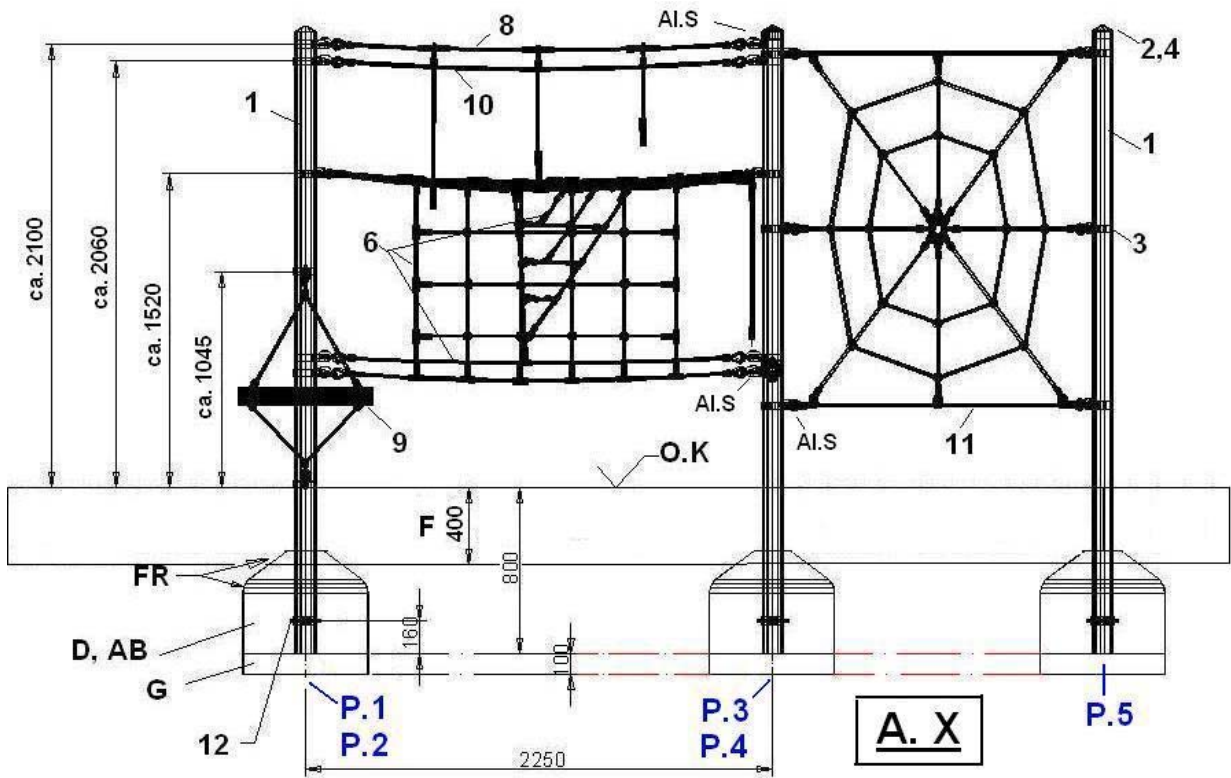
8	1	
9	1	
10	2	
11	1	 <p data-bbox="516 1969 808 2004"><b>Art.-Nr. 4591-30-8</b></p>
12	5	

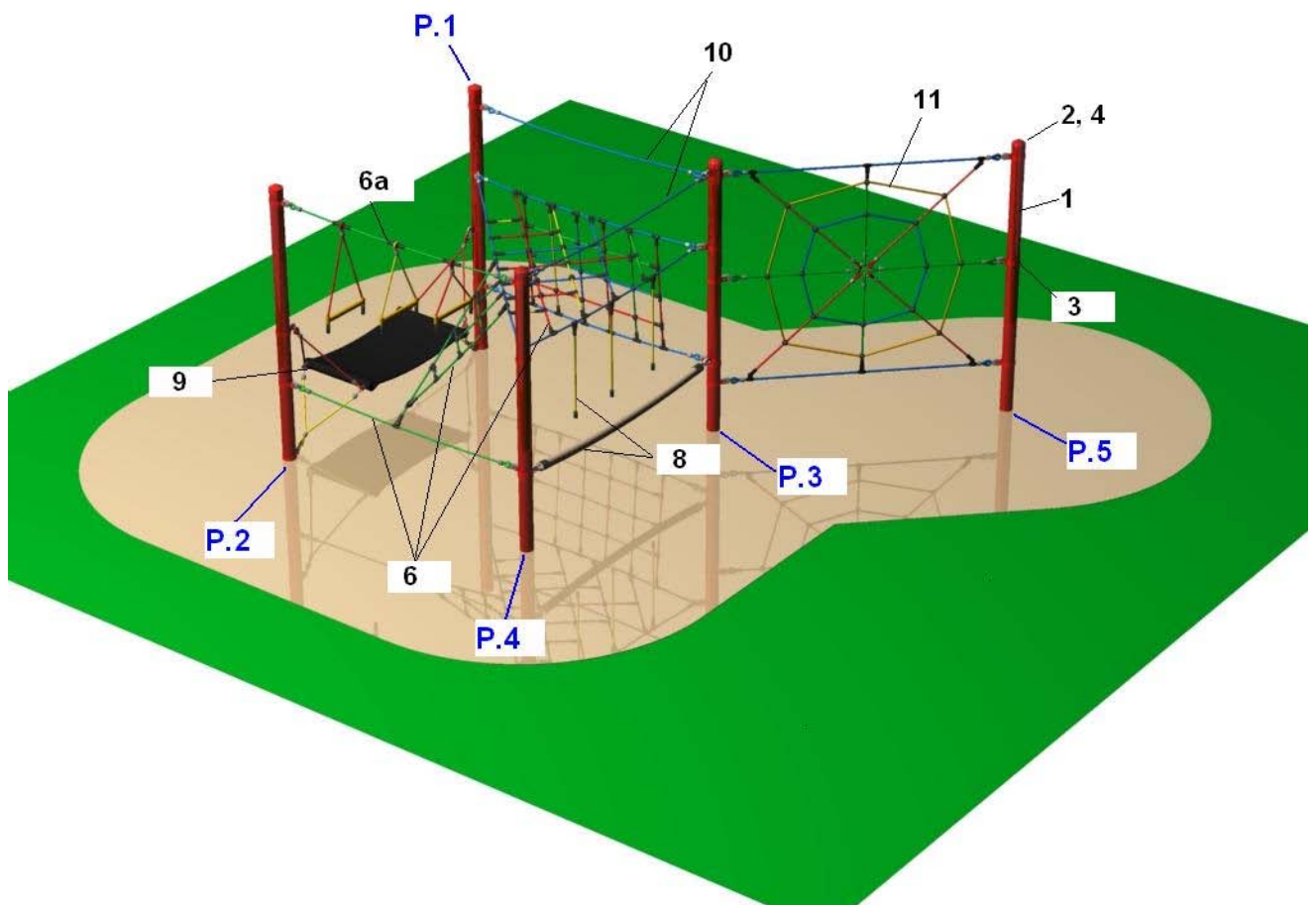
#### 4 Erection instructions











<b>AB</b>	Setting time for concrete at least 7-8 days
<b>D</b>	Concrete C25/30 (for foundation)
<b>F</b>	Fall protection
<b>FR</b>	Foundation radius at least 10 cm
<b>G</b>	Drainage layer 10 cm
<b>AM</b>	Unit spacing (centre-centre) posts
<b>LM</b>	Clearance post dimensions
<b>O.K</b>	Upper play level
<b>P.1 - 5</b>	Posts / foundation 1 - 5
<b>Al.S</b>	Aluminium adapter with steel clip
<b>PS</b>	Required space including safety area at least 33.4 m <sup>2</sup>
<b>DR</b>	Plan view

**See drawings**

## 5 Post installation checks

---



Notice

If the equipment has not been installed safely, you must ensure that the public is prevented from using it.

---

### 5.1 Marking filler depth

- Labelling the posts to show the depth of material provided as fall protection (i.e. loose filler).

### 5.2 The equipment has not been installed safely in the following cases:

- Safe equipment installation is not complete.
- The protective surface has not been installed yet.
- Appropriate maintenance work cannot guarantee operational safety.

### 5.3 Removal of all assembly aids

- Please make sure that all assembly aids have been removed from the playing area. The equipment must not be approved for use until this check has been made.

### 5.4 Information about inspection of the equipment before it is used for the first time

- There are no special inspection requirements to be met before the equipment is used for the first time.

### 5.5 Retighten bolts

- After one week of play, please retighten all bolts again. Later upon respective maintenance.

**B Maintenance instruction “System”**  
**System 1 + Element 8**  
**Art.-No. 4591-30 + Art.-No. 4591-30-8**  
(Version: Steel posts)



Introduction Maintenance

**5.6 General informations**

This equipment should be installed, inspected, maintained and operated in accordance with EN 1176-7 guidelines.



Notice

**Please note:** Providing any necessary repairs are carried out, a piece of play equipment that is inspected regularly cannot become so damaged that it is dangerous.

Any spare parts which may be required can be obtained directly from your supplier.



Attention

This equipment should only be assembled, maintained and repaired by **persons with the necessary expertise.**

**A copy of the inspection record should be given to the operator, who must confirm receipt.**

**This maintenance instruction is based on the standard  
“EN 1176-1:2008”.**

## **6 General maintenance information**

### **6.1 Maintenance intervals**

Maintenance intervals are based on average use. Please note that more frequent inspections and/or maintenance are required if the play equipment is subject to intensive use.

### **6.2 Inspection frequency**

The frequency of inspections must be based on actual use. Factors that affect frequency include vandalism, location (e.g. coastal proximity), air pollution and the age of the equipment.

### **6.3 Maintenance products and procedures**

All nuts and bolts are hot-dip galvanised or stainless steel. One of the characteristics of stainless steel is that uncontrolled cold welding may occur when the nuts are tightened. To prevent this, it is necessary to spray the nuts and bolts with Teflon spray or another similar lubricant.

### **6.4 Spare parts**

All spare parts must conform to the manufacturer's specifications.

### **6.5 Identifying spare parts**

All spare parts are listed in the parts list. The parts list follows the installation requirements.

### **6.6 Special instructions for the disposal of individual equipment components**

No special instructions are necessary for the disposal of individual equipment components.

### **6.7 Special measures during the break-in period**

No later than 2 weeks after assembly, all screwed connections should be checked and tightened if necessary.

### **6.8 Drainage holes**

All drainage holes should be kept clear.

### **6.9 Maintenance of protective surfaces**

Surfaces providing fall protection must also be maintained regularly. It is particularly important to maintain the correct level of loose surface material and add more if necessary.



## 6.10 Faults

---



Faults must be repaired as soon as they are detected. If serious defects that compromise safety cannot be repaired straight away, the public must be prevented from using the equipment with immediate effect.

## 6.11 Loose screws

---



Loose screws always cause quality problems and put safety at risk. Therefore, loose screws should always be tightened and checks carried out to ensure that there are no missing screws (e.g. look out for holes you can see through).

## 6.12 Preventing equipment use

Use of the equipment should be prevented in the event of incomplete installation, disassembly, maintenance, repairs and faults.

## 6.13 Claims/liability for faults

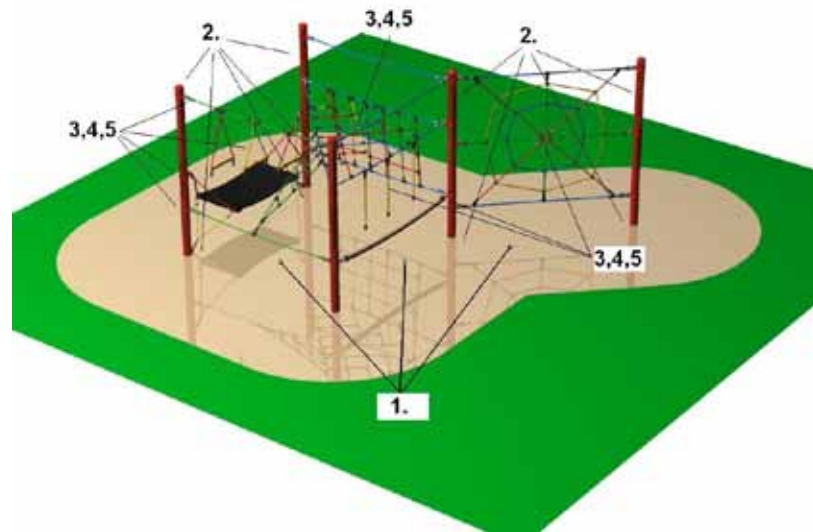
Steel posts and footings are guaranteed if regular maintenance is carried out and recorded in writing. Our general terms and conditions apply. Maintenance first takes place after 3 years. The steel posts must be excavated as far as the concrete foundations and checked for corrosion.

Zinc paint should be applied to any corroded areas and scratches.

Check ropes for abrasion. Retreat any that are very worn.

## 7 Regular maintenance

### 7.1 Image



## 7.2 Regular maintenance (Text)

m = monthly j = 1/4 quarterly j = 1/2 half-yearly

	m	¼ j	½ j
1. Check ground in fall and protection area for hard objects and loose foundations.	X		
2. Check stability (supporting posts, springs, supports, foundations etc.).			X
3. Check all connecting elements and fittings for wear and tear and where necessary retighten. Replace damaged components.	X		
4. Check that moveable metal components (joints, springs etc) move smoothly and are not worn and where necessary replace. It is not necessary to lubricate joints as we only use maintenance-free metal roller bearings.	X		
5. Check all attachments such as chains, ropes, nets, etc. for damage and replace if necessary	X		
6. Check rubber parts, sleeves, rings etc. for wear and tear or damage and replace if necessary.	X		
7. Check the surface of wooden parts for damage caused by the weather or external influences and repair (Paint with glaze) or replace if necessary.	X		
8. Check the surface of plastic and metal parts, e.g. slides, for damage and replace if necessary.	X		

It is recommended to carry out the **inspection and maintenance work** out in the specified time-frames, since wear and tear can occur through play, weathering influences or intentional damage, which compromises safety and function levels.

**Defects, which compromise safety, must be treated promptly, either by immediately repairing or dismantling or closing down the equipment!**

Defects, which compromise function, reduce the play value of the equipment and encourage vandalism, which may compromise safety levels. Damage should also be immediately repaired in this case.

**Maintenance and servicing is to be carried only out by professionals.**

**General:** Play equipment which is regularly checked may not be damaged in such a way that it becomes dangerous. However it is essential that where necessary repairs are followed up after regular checks.

## 8 Maintenance timetable

### 8.1 Special advices

#### 8.1.1 Maintenance interval

We strongly advise you to carry out inspections and maintenance work within the specified periods as use of the equipment, the weather and malicious vandalism cause wear and tear that compromises the safety and function of the equipment.

#### 8.1.2 Maintenance intervals in the event of intensive use

Please note that more frequent inspections and/or maintenance are required if the play equipment is subject to intensive use.

#### 8.1.3 Faults that compromise safety

---



Notice

In the event of a fault that compromises safety, quick action must be taken. This may involve repairing it immediately or shutting down and dismantling the equipment.

---

#### 8.1.4 Faults that compromise function

---



Notice

Faults that compromise function should also be repaired immediately. Such faults lower the value of the equipment to the user and encourage malicious vandalism, which may render the equipment less safe. Any damage should also be repaired immediately.

---

## 9 Monthly maintenance

- Check the spaces between the equipment and the ground (clearance and height of fall).
- Check the ground surface in the area with fall protection for hard objects and loose foundations.
- Check all connecting elements and fittings for wear and tear and tighten if necessary. Replace damaged or missing parts.
- Check that moving metal parts (joints, springs, etc.) move smoothly and are not worn. Replace if necessary. It is not necessary to lubricate joints as we only use maintenance-free metal roller bearings.
- Check all attachments such as chains, ropes, nets, etc. for damage and replace if necessary.
- Check rubber parts, sleeves, etc. for wear and tear or damage and replace if necessary.
- If necessary, remove excess padding material from the post footings due to danger of rotting.
- Check the surface of wooden parts for damage caused by the weather or external influences and mould. Repair or replace if necessary.
- Check the surface of plastic and metal parts, e.g. slides, for damage and replace if necessary.

## 10 Quarterly maintenance

- Detailed inspection of the operation and stability of the equipment paying particular attention to any wear and tear.
- Tighten all forms of attachment.
- Repaint and retreat surfaces.
- Maintenance of fall protection surfaces.
- Lubrication of joints.
- Check the height of the fall and top up with loose filler if necessary. If the posts are labelled, top up as far as the mark.
- Retighten all bolts

## 11 Half yearly maintenance

- The stability of supporting posts, supports, foundations etc is to be checked. The safety level of the entire system is to be checked after repairs have been carried out or additional system components have been installed or replaced.



## Annual Maintenance

---

### 12 Annual maintenance

- Ascertaining that the equipment, foundations and surfaces are safe for operation.
- In particular, the equipment should be checked for decay and corrosion. It may be necessary to dig out or excavate certain components in order to do so. Zinc paint should be applied to corroded areas and scratches.
- Stability (check posts, bracing, foundations, etc.).
- Ascertaining whether there are any changes in equipment safety as a result of repairs that have been carried out or components that have been added or replaced.



The equipment must be inspected by someone **with the necessary expertise** in strict compliance with the instructions issued by Huck Seiltechnik GmbH.

**A copy of the inspection record should be given to the operator, who must confirm receipt.**

---



## 14 Hand over document



After the installation of the equipment pass the installation and maintenance documents to the operator. The operator has to receive the hand over documents. The complete filled and signed hand over document should be sent to the supplier.

Art.-No.: 4591-30 + 4591-30-8

Type of item: SYSTEM 1 + Element 8

Serial number:

**Customer or operator (Town, Town council, Kindergarten, etc.):**

---

---

Competent person in charge:

---

---

**Installation company (address):**

---

---

Responsible assistant (assembler):

---

---

Received the complete assembly instructions, maintenance instructions and maintenance printout .

---

(Signature of operator)      (Signature of installation company)  
(Stamp)

Date: \_\_\_\_\_