

---

**A Assembly Instructions for  
Trampoline 2000 with: Installation Frame,  
Special Installation Frame,**

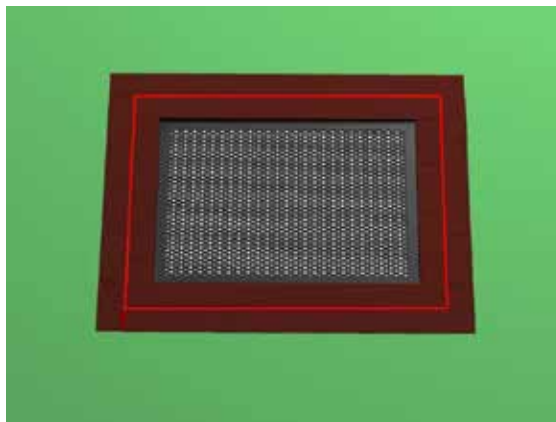
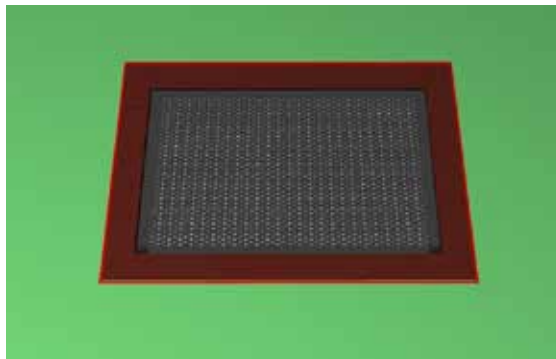

Operator: \_\_\_\_\_

Location: \_\_\_\_\_

Revision history  
Revision 0 – 2009-10-4  
First allowed Version  
Revision 3 – 2010-05-26

## Contents

<b>A</b>	<b>Assembly Instructions for Trampoline 2000 Art.- Nr. 20.02.125 <u>with:</u> Installation Frame, Art.- Nr. 20.02.123 or Special Installation Frame, Art.- Nr. 20.02.128.....</b>	<b>1</b>
	<b>Introduction Assembling .....</b>	<b>4</b>
	<b>Datasheet Trampoline 2000 Art. Nr. 20.02.125 + Art.-Nr. 20.02.123 (Foundation frame) or (optional) Special foundation frame Art.-Nr. 20.02.128.....</b>	<b>6</b>
	<b>Delivery contents (parts list with part numbers).....</b>	<b>6</b>
1.1	in Symbols.....	7
	<b>Post installation checks.....</b>	<b>24</b>
<b>B</b>	<b>Maintenance Instructions Trampoline 2000 Art.-Nr. 20.02.125 <u>with:</u> Installation Frame Art.- Nr. 20.02.123 or Special Installation Frame, Art.- Nr. 20.02.128.....</b>	<b>25</b>
	<b>Introduction Maintenance.....</b>	<b>27</b>
	<b>General maintenance information .....</b>	<b>28</b>
	<b>Specific maintenance advice .....</b>	<b>29</b>
	<b>Maintenance timetable .....</b>	<b>30</b>
	<b>Monthly maintenance.....</b>	<b>31</b>
	<b>Quarterly maintenance .....</b>	<b>32</b>
	<b>Annual maintenance .....</b>	<b>33</b>
<b>2</b>	<b>Hand over document .....</b>	<b>37</b>

## List of Tables

Tabelle 3-1: Delivery contents, in words.....	6
Table 3-2: Delivery contents, in symbols .....	7

---

## Introduction Assembling

### General information

This equipment should be installed, inspected, maintained and operated in accordance with EN1176-7 guidelines.

**Before installation work commences, please check that you have all of the equipment and fixation components in the parts list provided (see Tables 3-1 and 3-2).**

**Please consider that the installation has to be carried out only on even terrain (max. slope up to 3%).**

Any spare parts that may be required can be obtained directly from your supplier.



### Attention

Following installation, complete assembly instructions, maintenance instructions and a maintenance record must be sent to the operator who must confirm receipt in writing. See the last page of this document.



### Attention

All nuts and bolts are hot-dip galvanised or stainless steel.

One of the characteristics of stainless steel is that uncontrolled cold welding may occur when the nuts are tightened. To prevent this, it is necessary to spray the nuts and bolts with Teflon spray or another similar lubricant.

---

**We hereby confirm that this play equipment has been tested and certified in accordance with the play equipment standard EN 1176.**

## Drawings / Views

All optical drawings are showing only the measurements/dimensions and are no mandatory technical views of the complete item.

---

We reserve the right to change technical details of our articles which are serving for the further development of our articles and are reasonable for the customer.

**Measurement tolerances**

Because of the properties and characteristics of the components, minor measurement tolerances compared to the indication on the sketches are possible. This concerns all shown measurements except the foundation measurements resp. measurements below upper edge ground level/play area.

**Datasheet Trampoline 2000**

**Art. Nr. 20.02.125 + Art.-Nr. 20.02.123 (Installation frame) or (optional) Special installation frame Art.-Nr. 20.02.128**

Space requirement 3,00 m x 2,25 m **and/or** 5,50m x 4,75 m including safety zone

Required safety surface:

Surface material	Description mm	Minimum thickness of layer mm	Maximum height of fall mm
Topsoil grass			<= 1000*
Chipped bark	20 – 80 grain size	400	<= 3000
Wood chippings	5 – 30 grain size	400	<= 3000
Sand	0.2 – 2 grain size	400	<= 3000
Gravel	2 – 8 grain size	400	<= 3000
Other ground materials	As recommended by manufacturer		

1. Name and overall dimension of the largest component:  
1 Trampoline 3,00 m x 2,25 m
2. Name and weight of the heaviest component:  
Trampoline 300 kg
3. Intended age group: 3 years and over

**Excavation area:**

1 x 3,20 m long x 2,40 m wide, 0,565 m deep incl. 10 cm drainage layer

Assembly time, once groundwork is complete: 2-3 hours.

Required assistance: 6 people

Any spare parts which may be required can be obtained directly from your supplier

**We hereby confirm that this item of play equipment has been tested and certified in accordance with the play equipment standard EN 1176.**

**Delivery contents (parts list with part numbers)**





Tabelle 3-1: Delivery contents, in words

Pos.	Quantity	Element / Description	Size	O.K.	Mis-sing
1	1	Trampoline	3,00 m x 2,25 m		
2	1	Installation frame Art.-Nr. 20.02.123	3,00 m x 2,25 m		
3	16	Selfdrilling screws	4,8 x 50 mm		

Pos.	Quantity	Element / Description	Size	O.K.	Mis- sing
2a	1	Special installation frame Art.-Nr. 20.02.128  - optional -	3,00 m x 2,25 m		

1.1 in Symbols

Table 3-2: Delivery contents, in symbols

Pos.	Quantity	Symbol
1	1	 Art.-Nr. 20.02.125
2	1	 Art.-Nr. 20.02.123
3	16	 4,8 x 50 mm
2a	(1)	 optional Art.-Nr. 20.02.128

Erection instructions

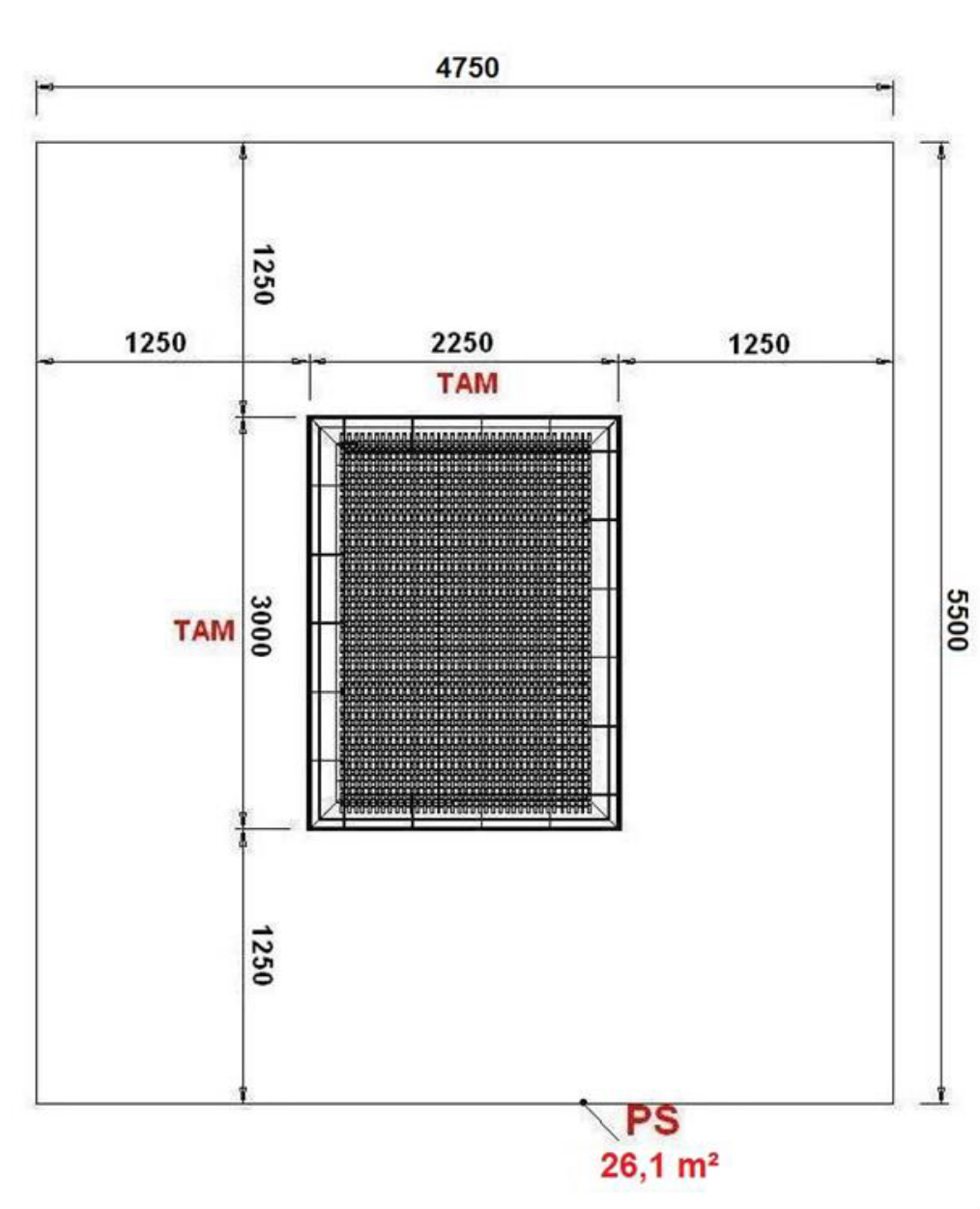



## Attention !!!

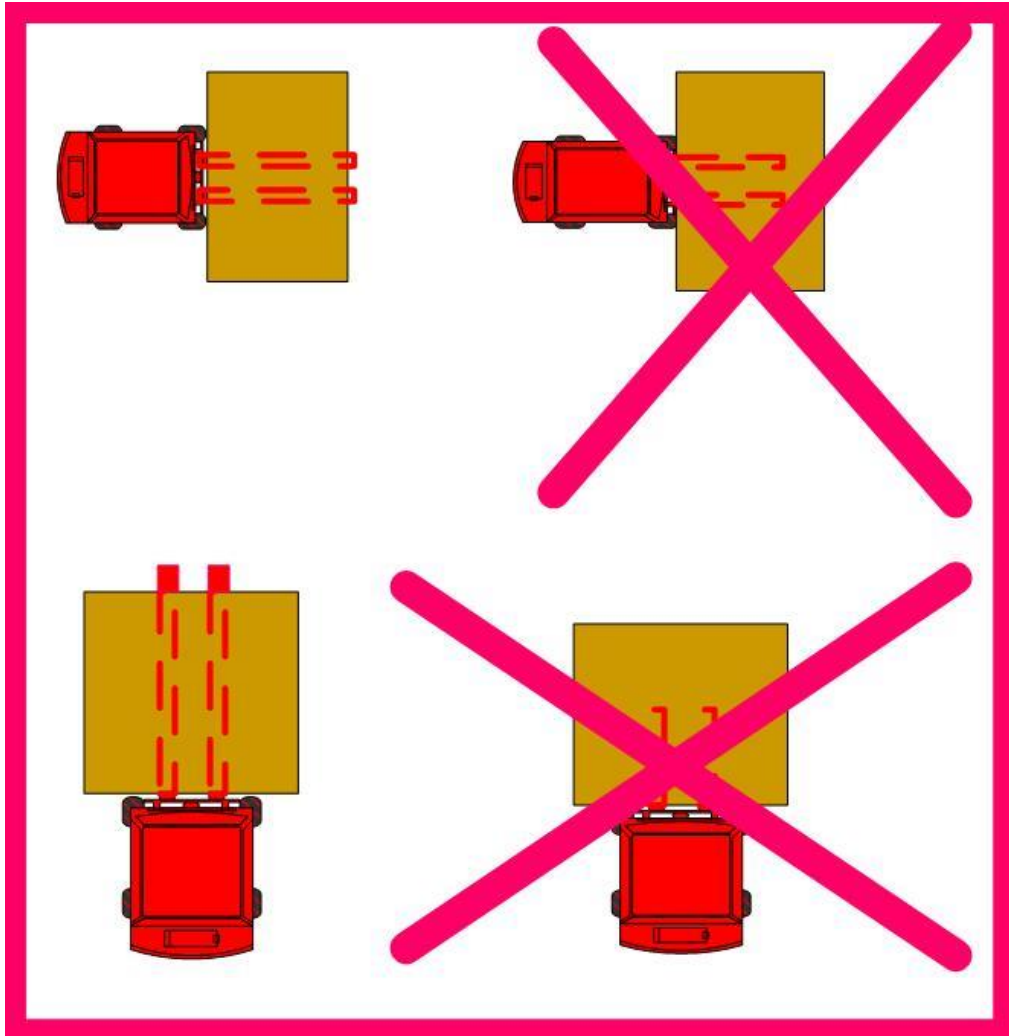

**Handle with care !!!**

**Check for transport damages before and after unloading from Transporter!!!**

**Do not raise Trampoline on the inner rubber edging!!!**

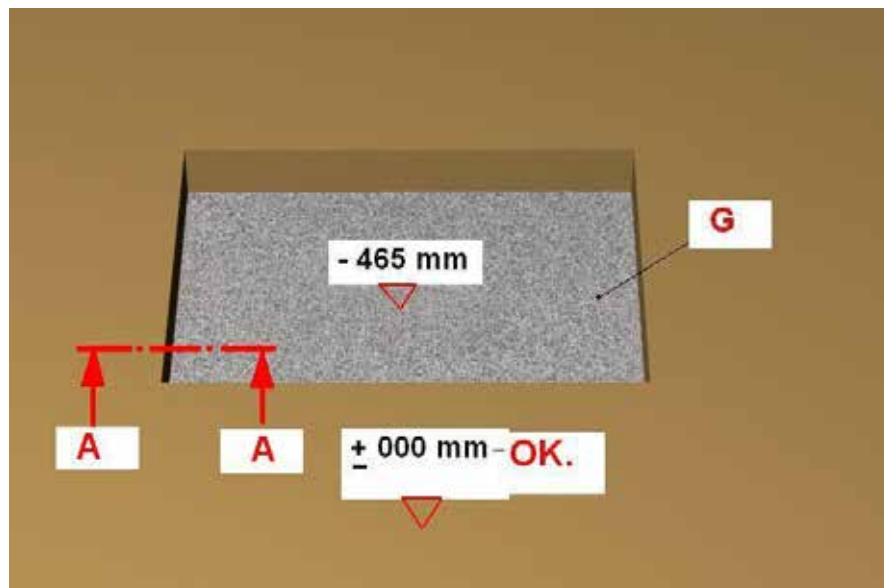
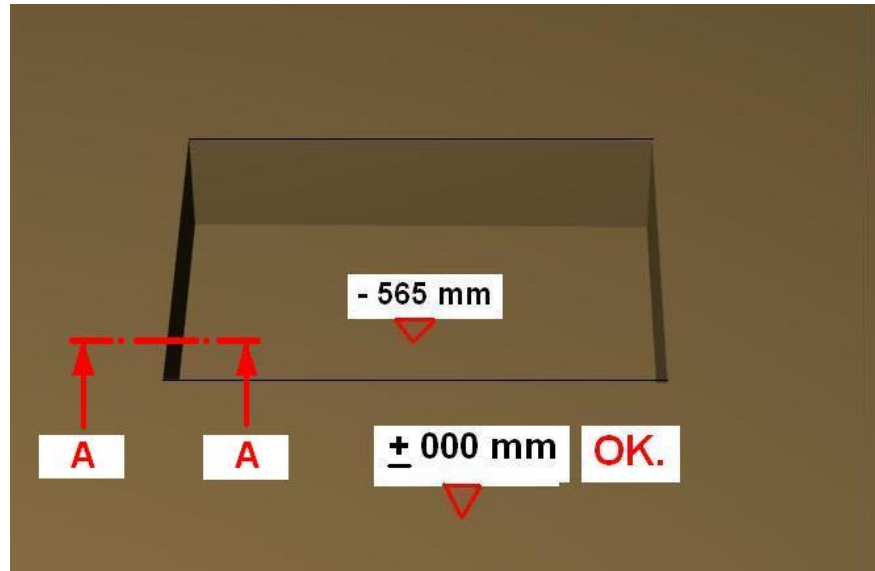

Art.-Nr./No.: 20.02.125 + 20.02.123

S: A - A

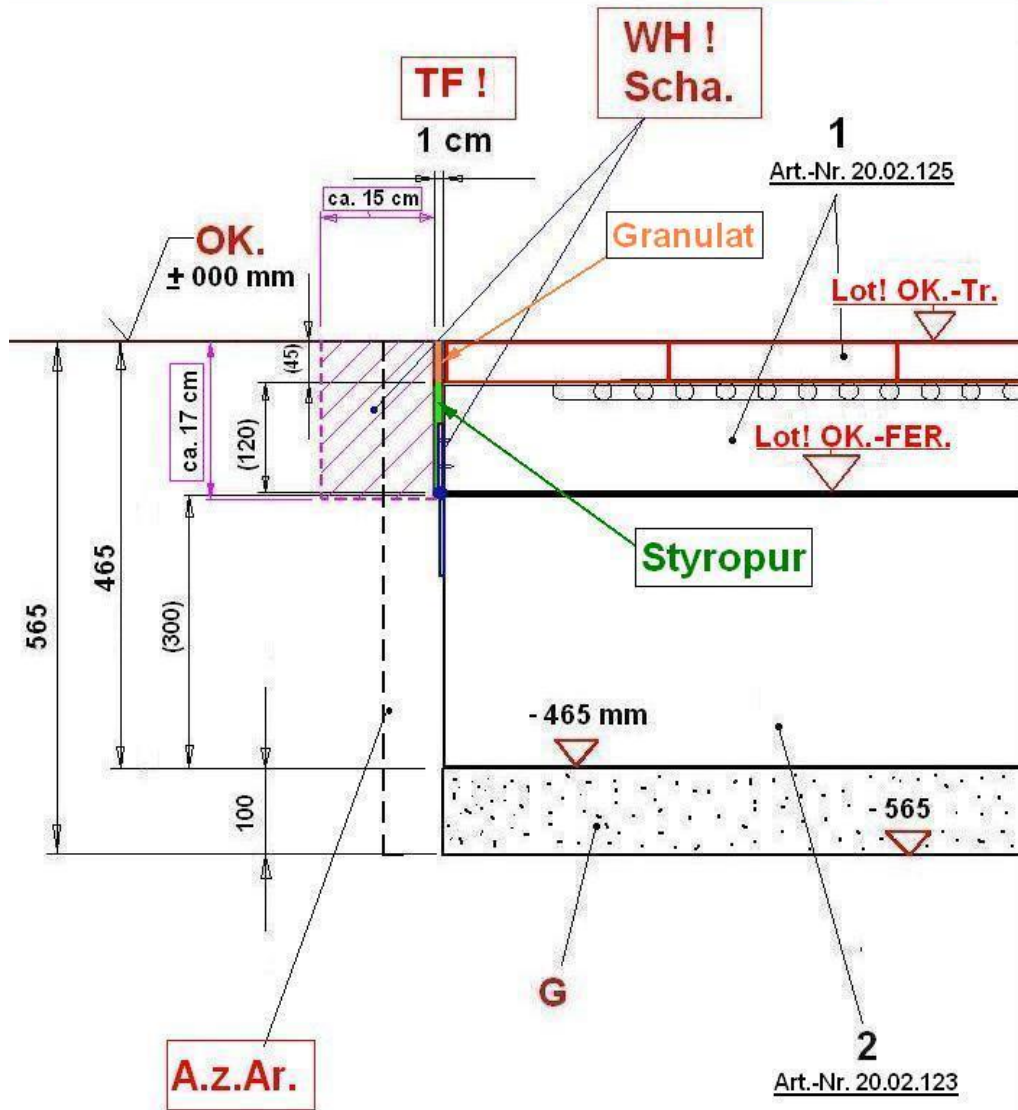

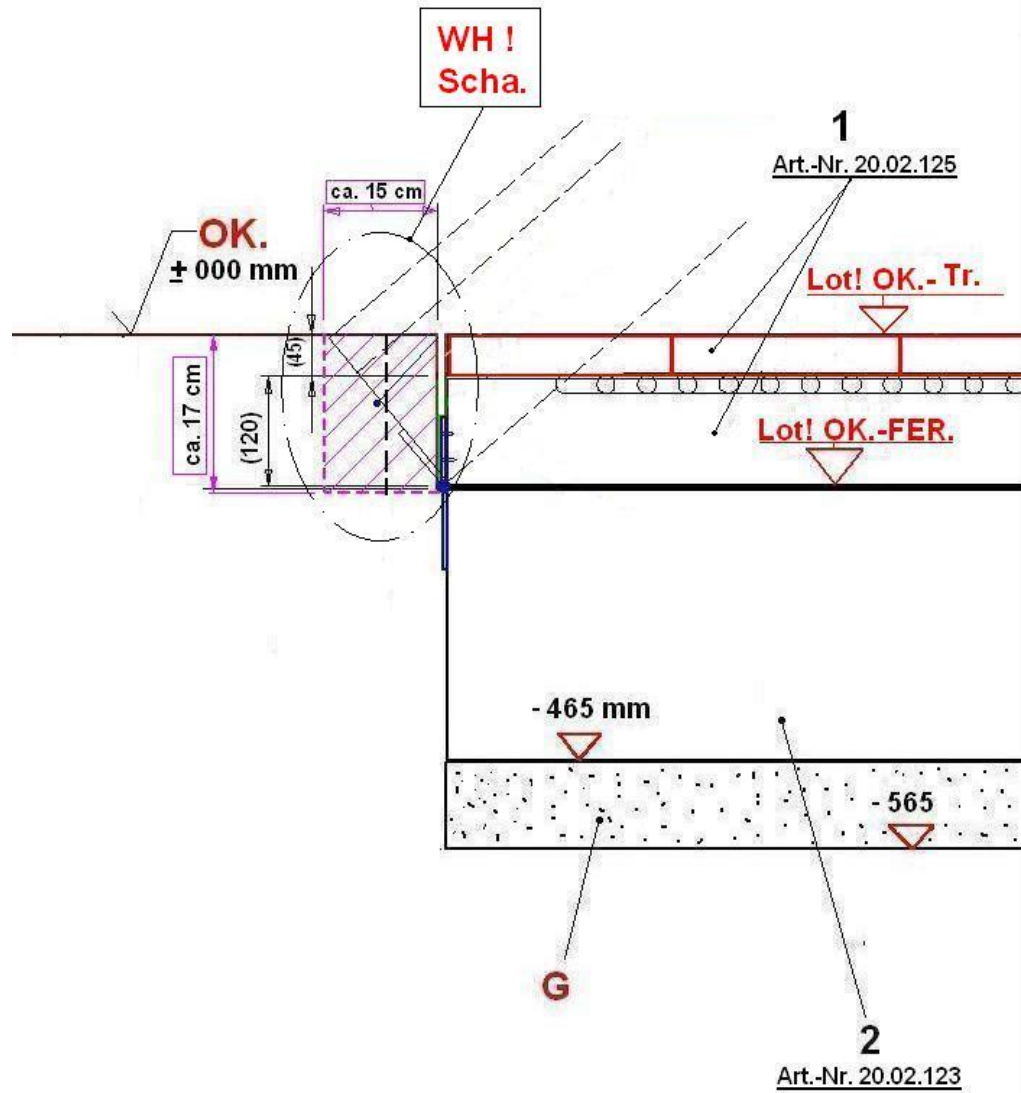

Art.-Nr./No.: 20.02.125 + 20.02.123 **S: A - A**

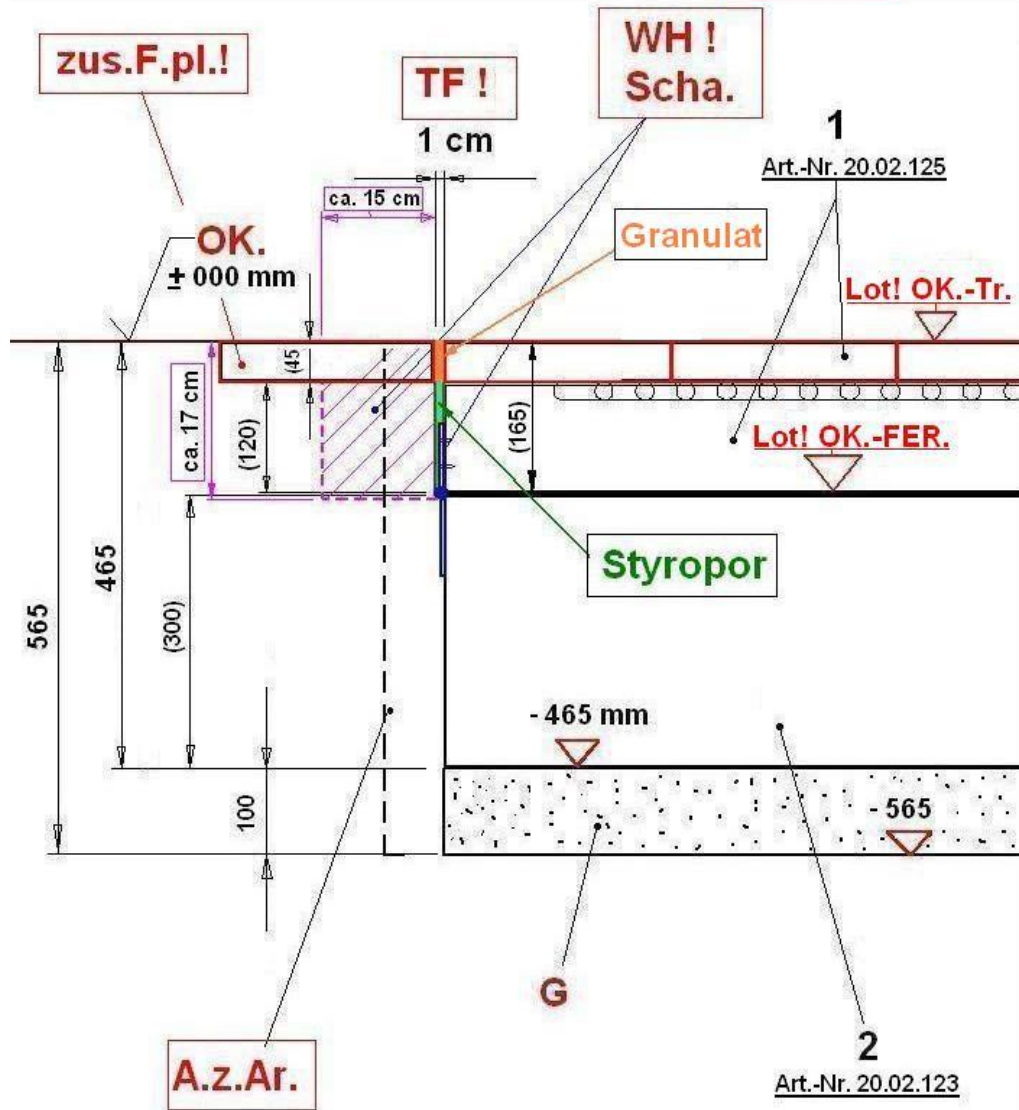

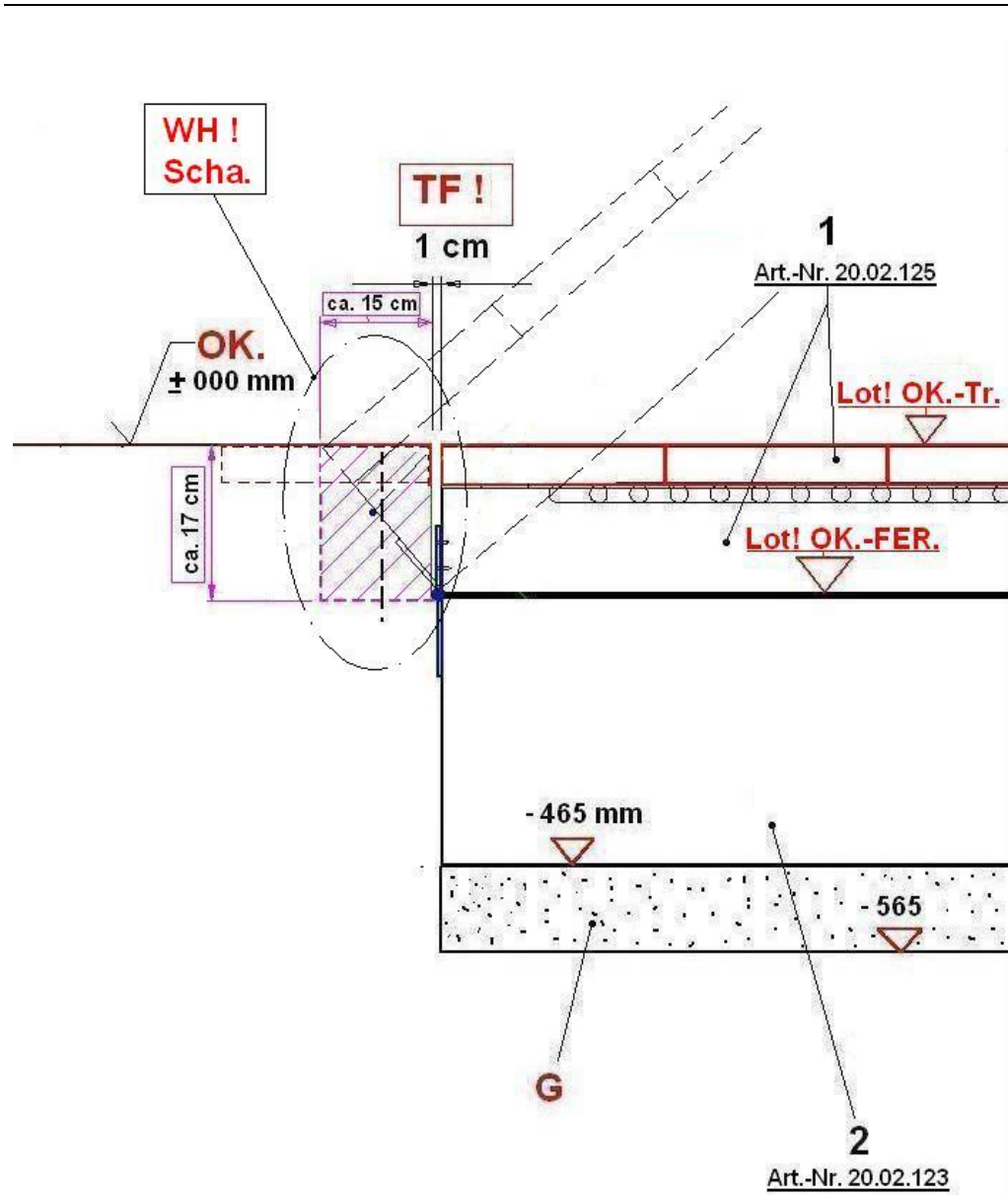

**Art.-Nr./No.: 20.02.125 + 20.02.123**

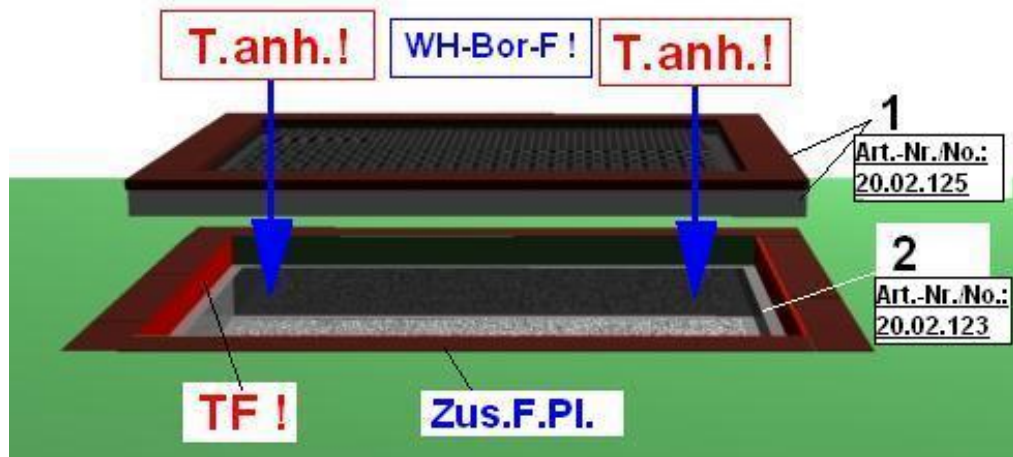
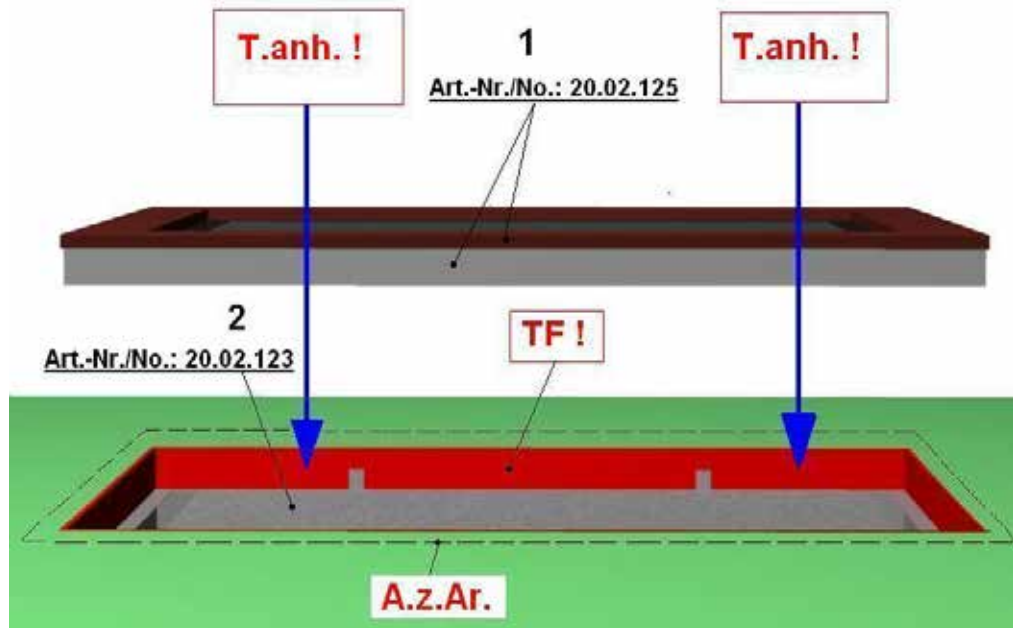

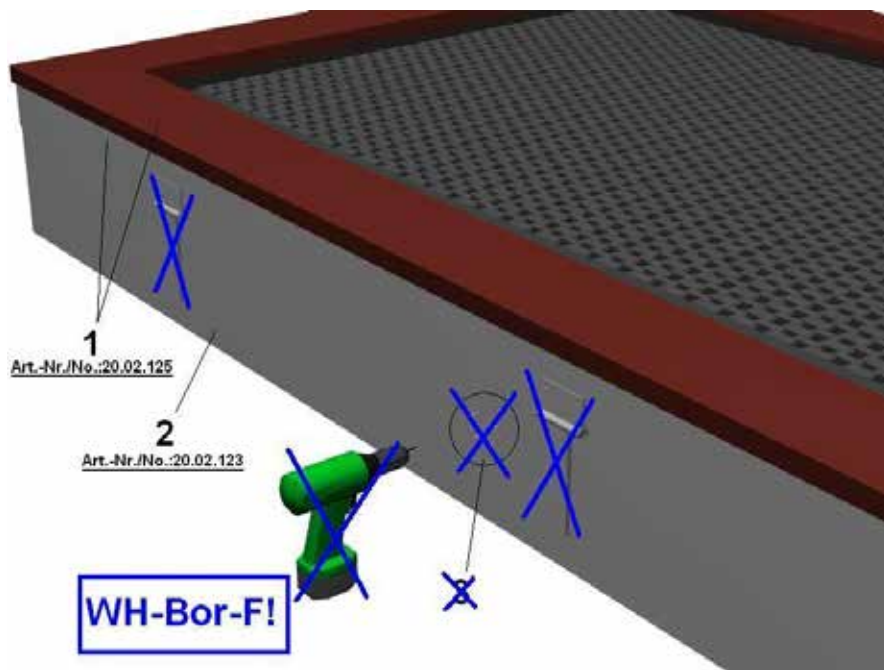
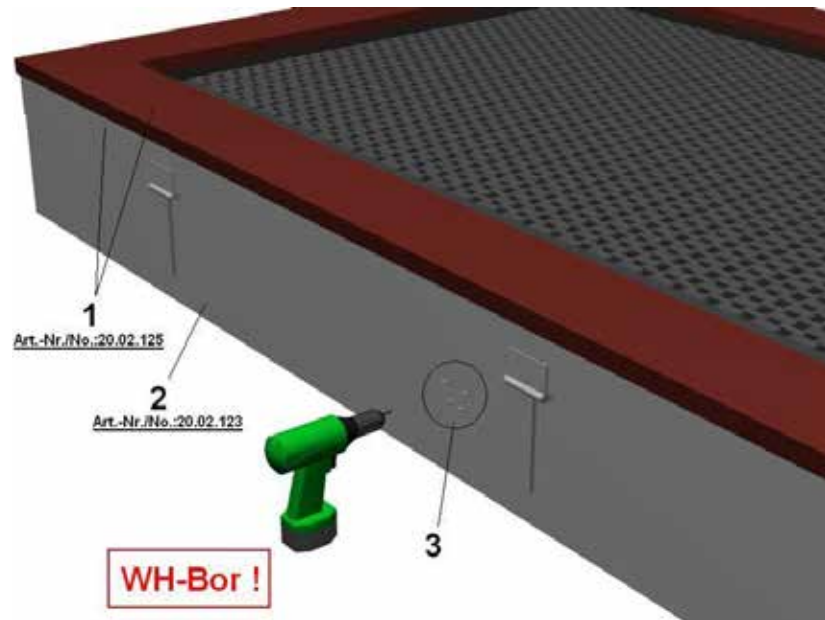



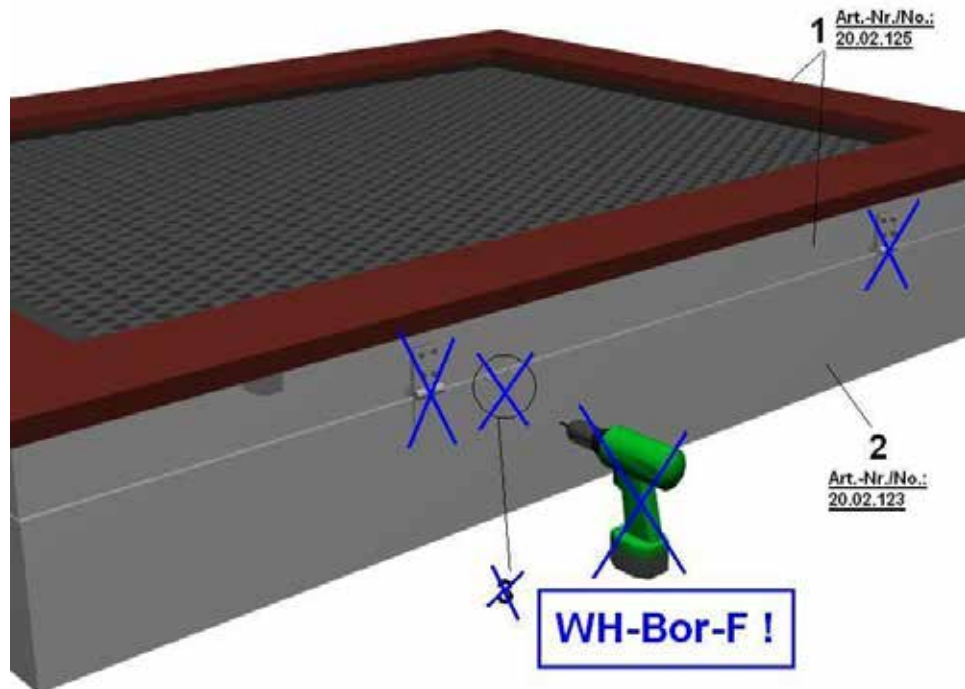
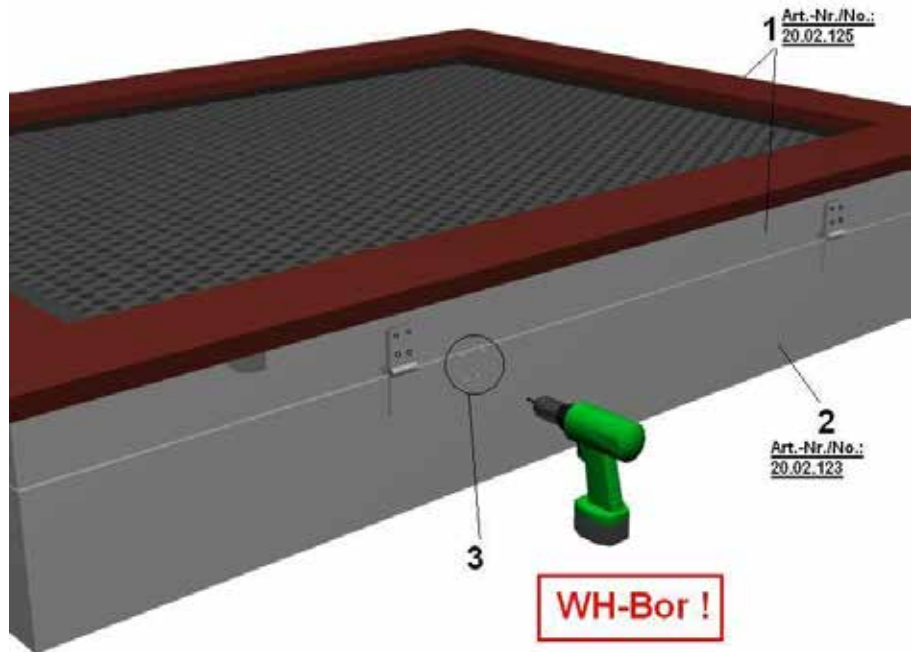

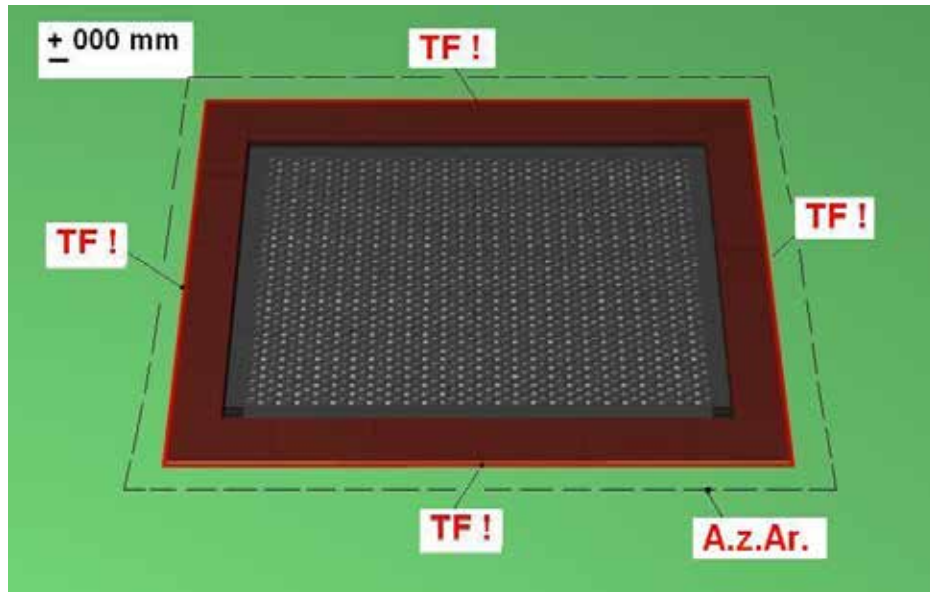

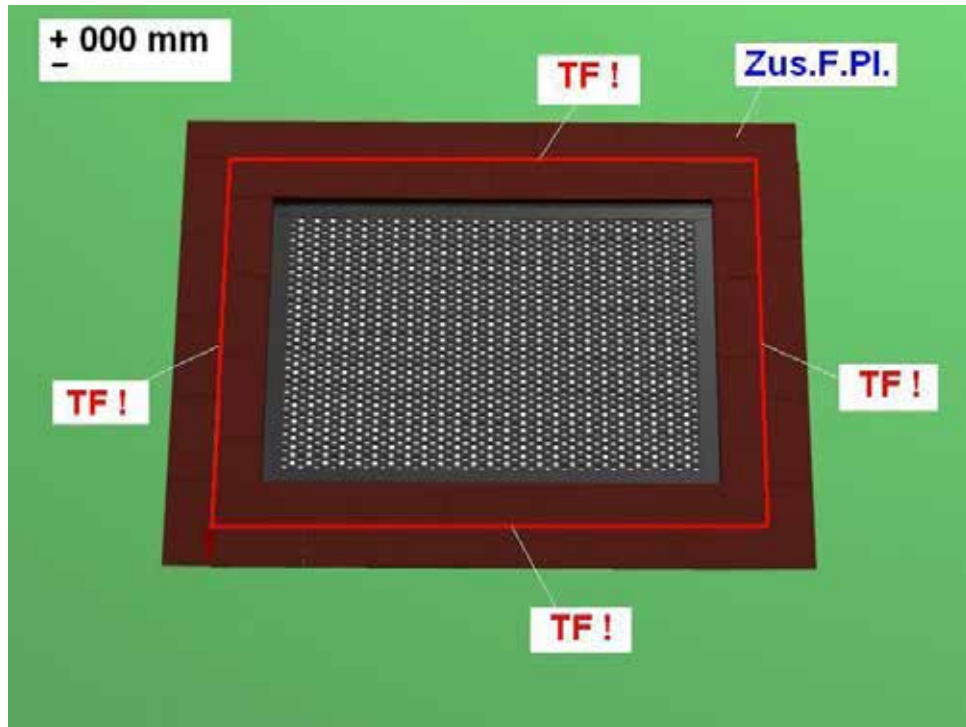

Art.-Nr./No.: 20.02.125 + 20.02.128

S: A - A

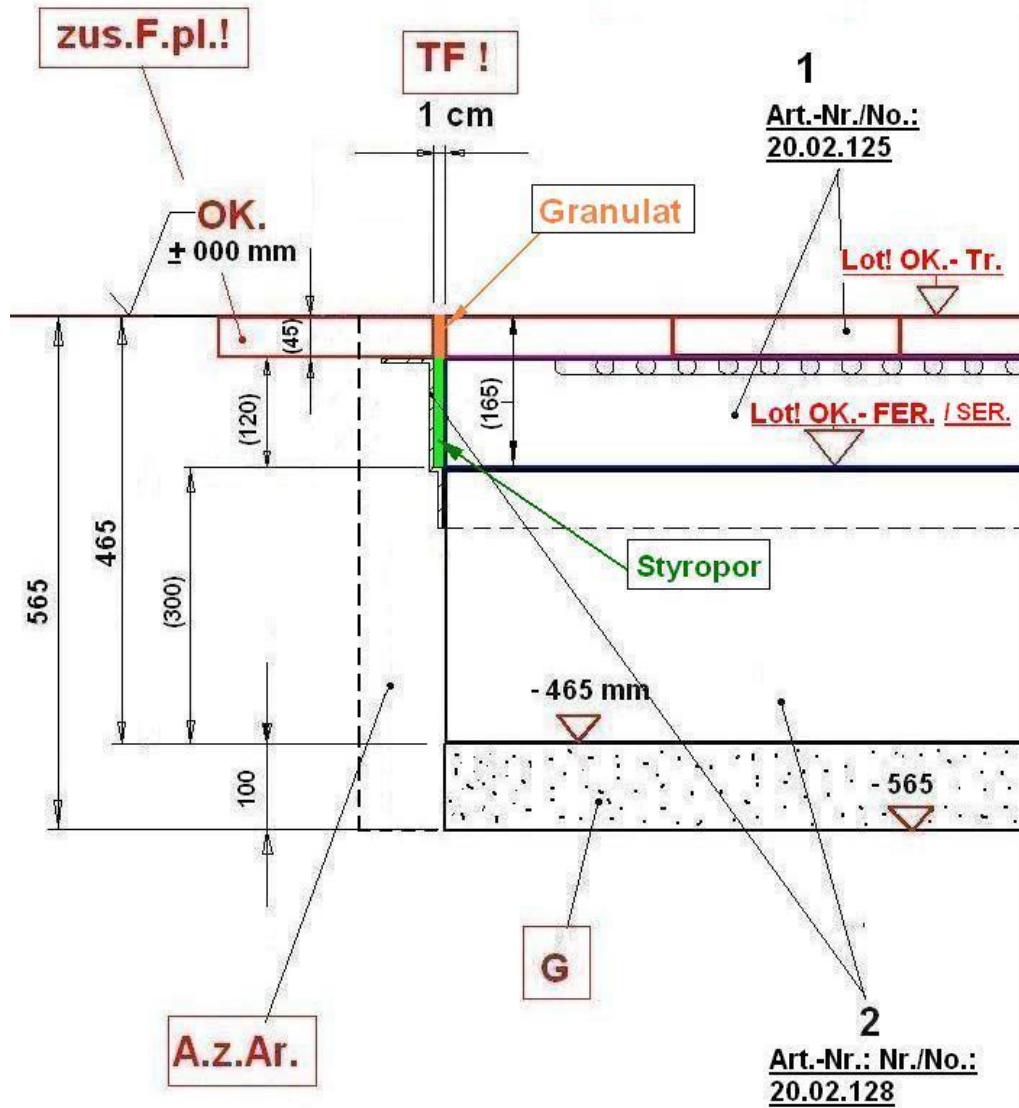

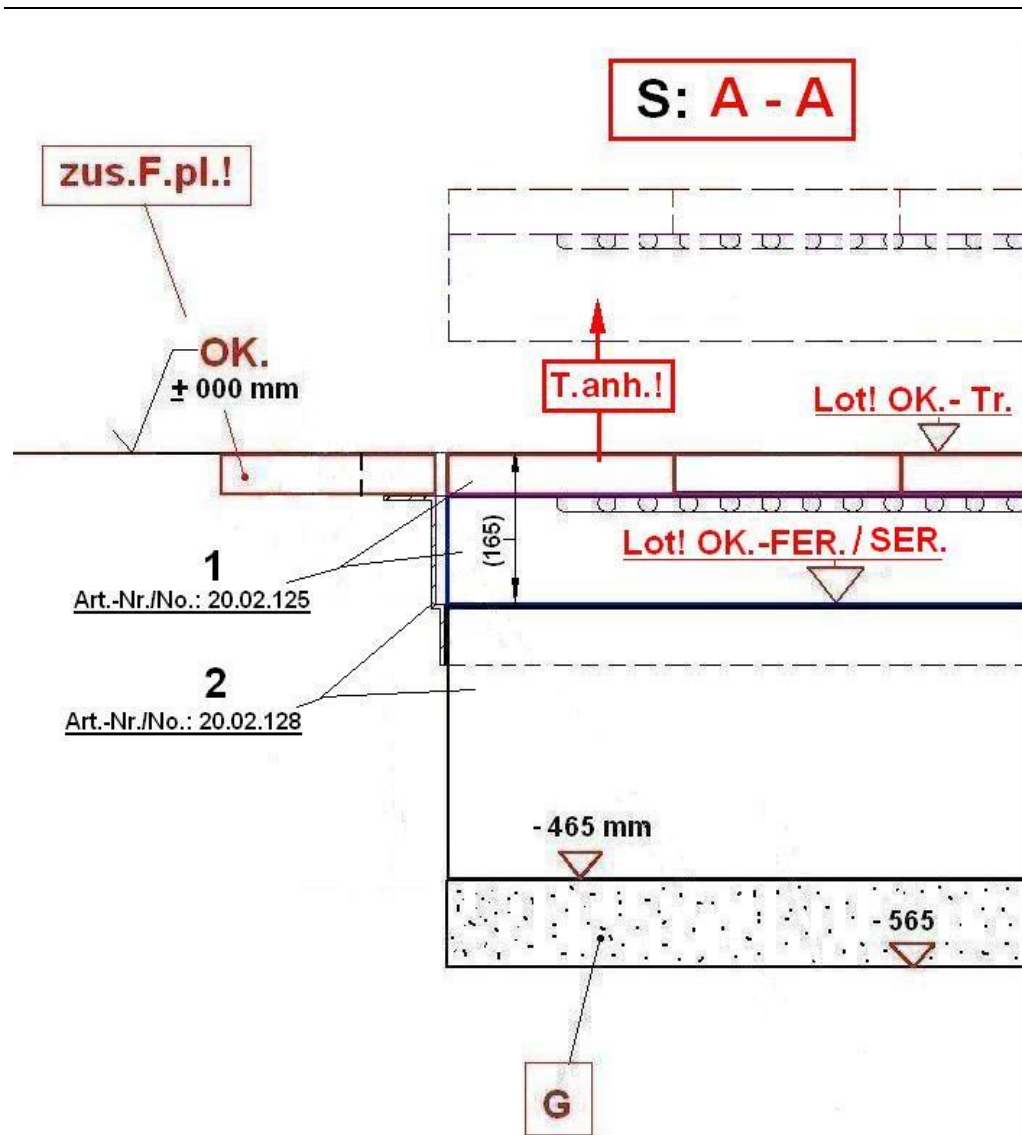

	<b><u>Explaining abbreviations and signs:</u></b>
<b>AB</b>	<u>Setting time for concrete C20/25 (B25)</u>
<b>D</b>	<u>Concrete: C20/25 (B25)</u>
<b>A.z.Ar.</b>	<u>Excavate 3,20 m x 2,40 m =</u> <b>Trampoline/Foundation frame (3,00 m x 2,25 m)</b>
<b>A.z. AS.</b>	<b>Required space for mounting hinges</b>
<b>G</b>	Drainage layer
<b>O.K.</b>	Top-ground surface
<b>PS</b>	Required space including safety zone
<b>S: A - A</b>	View: A - A
<b>Fun-S.</b>	<u>Foundation boards</u> (provided by customer)
<b>TF !</b>	<u>Parting line 1 cm around the Trampoline / (shown in orange in diagrams) !!</u>
<b>WH ! Schar</b>	<p><b><u>Important notice on cleaning!!!</u></b>  <u>Normal surfacing(grass , sand , etc.)</u></p> <p>1.) Remove the 2 small screws on the safety hinge before opening to clean.</p> <p>2.) Excavate surrounding surface material so that the trampoline can be folded open.</p> <p>3.) Use support beams(MIN.8x8cm) while cleaning is done!!!</p> <p>4.) After cleaning is complete, refit the safety hinge screws and refill excavated materials.</p> <p><b><u>Rubber Tiles or other composite surfacing !</u></b></p> <p>5.) If wet pour or other composite surfacing is used, tiles made of the same substance should be installed around the sides so that they can be removed for folding trampoline open during cleaning!  <u>(View on page 15 !)</u></p>
<b>WH-Bor !</b>	Connect trampoline to foundation frame
<b>Zus.F.PI.</b>	<b><u>Provided upon request!</u></b> Wet pour tiles placed around trampoline
<b>WH-Bor-F !</b>	<p><b><u>Attention !!!</u></b>  <u>Where Wet Pour or other composite surfacing is used ! ( except for Rubber Tiles! )</u></p> <p>Do not install folding or safety hinges because the trampoline cannot be folded open! It must be lifted manually by at least 6 people or by using a lifting device (not included in delivery contents)</p>

<p><b>T.anh. !</b></p>	<p><b><u>Lifting trampoline to install or clean!</u></b></p> <p><b><u>(1. Trampoline in natural ground surfacing)</u></b></p> <p><b><u>Installing:</u></b> View <b>A.z.Ar.</b> When lifting or lowering the trampoline pay attention that it is equally lifted on all 4 outer corners ! The Trampoline must be installed evenly onto the foundation.</p> <p><b><u>Cleaning:</u></b> After excavating the area on the folding hinge side has been done, proceed as followed: <b>WH ! Scha .</b></p> <p><b><u>(2. Trampoline with Rubber Tiles)</u></b></p> <p><b><u>Attention !!!</u></b> <b><u>With additional rubber tiles ! ! (at customers request)</u></b></p> <p><b><u>Installing:</u></b> View <b>A.z.Ar.</b> When lifting or lowering the trampoline pay attention that it is equally lifted on all 4 outer corners ! The Trampoline must be installed evenly onto the foundation.</p> <p><b><u>Cleaning:</u></b> Arter removing rubber tiles and excavating the area on the folding hinge side, proceed as followed <b>WH ! Scha. – View part 3 !</b></p> <p><b><u>(3. Trampoline + Wet Pour or other closed composite surfacing)</u></b></p> <p><b><u>Attention !!!</u></b> <b><u>Wet Pour or other closed composite surfacing!</u></b></p> <p><b><u>Installing:</u></b> View <b>A.z.Ar.</b></p> <p><b><u>Cleaning:</u></b> When lifting or lowering the trampoline pay attention that it is equally lifted on all 4 outer corners ! The Trampoline must be installed evenly onto the foundation.</p>
<p><b>Lot ! OK.-Tr.</b></p>	<p><b><u>Upper edge of Trampoline:</u></b> Install equally level.</p>
<p><b>Lot ! OK.-D.</b></p>	<p><b><u>Upper edge of foundation:</u></b> Install equally level.</p>
<p><b>TAM</b></p>	<p>Trampoline outer measurments</p>
	<p><b><u>Pay attention that the parting line/joint is kept clean!</u></b></p>
<p><b>Styrofo- am</b></p>	<p>Place 1cm thick styrofoam in the area around the trampoline (max. height of the styrofoam ist the lower edge of outer rubber surfacing</p>

	on top of the trampoline!) (view diagram)
<b>Sand</b> (Granulat)	Fill the parting line/joint with sand or granulate! (view diagram)

### Post installation checks



If the equipment has not been installed safely, you must ensure that the public is prevented from using it.

### Marking filler depth

Labelling the posts to show the depth of material provided as fall protection (i.e. loose filler).

### The equipment has not been installed safely in the following cases:

- Safe equipment installation is not complete.
- The protective surface has not been installed yet.
- Appropriate maintenance work cannot guarantee operational safety.

### Removal of all assembly aids

Please make sure that all assembly aids have been removed from the playing area. The equipment must not be approved for use until this check has been made.

### Information about inspection of the equipment before it is used for the first time

There are no special inspection requirements to be met before the equipment is used for the first time.

### Retighten bolts

After one week of play, please retighten all bolts again. Later upon respective maintenance.



---

**B Maintenance Instructions**  
**Trampoline 2000 Art.-Nr. 20.02.125 with:**  
**Installation Frame [Art.- Nr. 20.02.123](#) or Special Installation**  
**Frame, [Art.- Nr. 20.02.128](#)**

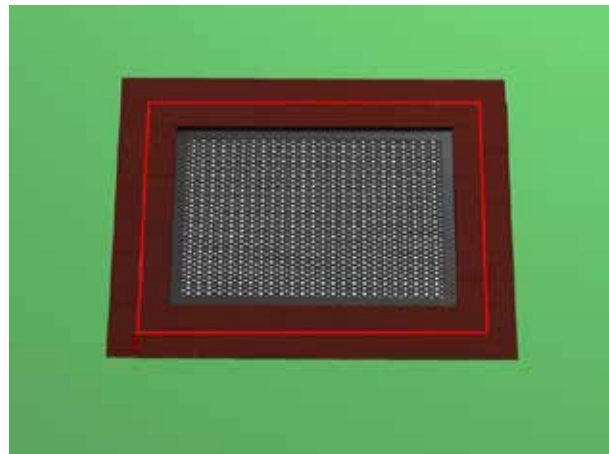
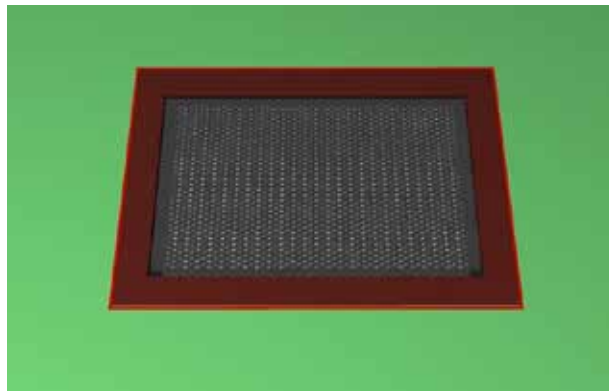

**Revisionshistorie**  
Revision 0 – 2009-10-4  
Maintenance instructions. Revision 3 – 2010-05-26

---

## Introduction Maintenance

### General informations

This equipment should be installed, inspected, maintained and operated in accordance with EN 1176-7 guidelines.



Notice

**Please note:** Providing any necessary repairs are carried out, a piece of play equipment that is inspected regularly cannot become so damaged that it is dangerous.

---

Any spare parts which may be required can be obtained directly from your supplier.



Attention

This equipment should only be assembled, maintained and repaired by **persons with the necessary expertise**.

**A copy of the inspection record should be given to the operator, who must confirm receipt.**

---

**This maintenance instruction is based on the standard  
"EN 1176-1:2008".**

---

## **General maintenance information**

### **Maintenance intervals**

Maintenance intervals are based on average use. Please note that more frequent inspections and/or maintenance are required if the play equipment is subject to intensive use.

### **Inspection frequency**

The frequency of inspections must be based on actual use. Factors that affect frequency include vandalism, location (e.g. coastal proximity), air pollution and the age of the equipment.

### **Maintenance products and procedures**

All nuts and bolts are hot-dip galvanised or stainless steel. One of the characteristics of stainless steel is that uncontrolled cold welding may occur when the nuts are tightened. To prevent this, it is necessary to spray the nuts and bolts with Teflon spray or another similar lubricant.

### **Spare parts**

All spare parts must conform to the manufacturer's specifications.

### **Identifying spare parts**

All spare parts are listed in the parts list. The parts list follows the installation requirements.

### **Special instructions for the disposal of individual equipment components**

No special instructions are necessary for the disposal of individual equipment components.

### **Special measures during the break-in period**

No later than 2 weeks after assembly, all screwed connections should be checked and tightened if necessary.

### **Drainage holes**

All drainage holes should be kept clear.

### **Maintenance of protective surfaces**

Surfaces providing fall protection must also be maintained regularly. It is particularly important to maintain the correct level of loose surface material and add more if necessary.

---

### Faults

---



#### Attention

Faults must be repaired as soon as they are detected. If serious defects that compromise safety cannot be repaired straight away, the public must be prevented from using the equipment with immediate effect.

---

### Loose screws

---



#### Attention

Loose screws always cause quality problems and put safety at risk. Therefore, loose screws should always be tightened and checks carried out to ensure that there are no missing screws (e.g. look out for holes you can see through).

### Preventing equipment use

Use of the equipment should be prevented in the event of incomplete installation, disassembly, maintenance, repairs and faults.

### Safeguarding the guarantee

Steel posts and footings are guaranteed if regular maintenance is carried out and recorded in writing. Maintenance first takes place after 3 years. The steel posts must be excavated as far as the concrete foundations and checked for corrosion. Zinc paint should be applied to any corroded areas and scratches.

### Specific maintenance advice

None

---

## Maintenance timetable

### Special advices

#### Maintenance interval

We strongly advise you to carry out inspections and maintenance work within the specified periods as use of the equipment, the weather and malicious vandalism cause wear and tear that compromises the safety and function of the equipment.

#### Maintenance intervals in the event of intensive use

Please note that more frequent inspections and/or maintenance are required if the play equipment is subject to intensive use.

---

## Faults that compromise safety



Notice

In the event of a fault that compromises safety, quick action must be taken. This may involve repairing it immediately or shutting down and dismantling the equipment.

---

## Faults that compromise function



Notice

Faults that compromise function should also be repaired immediately. Such faults lower the value of the equipment to the user and encourage malicious vandalism, which may render the equipment less safe. Any damage should also be repaired immediately.

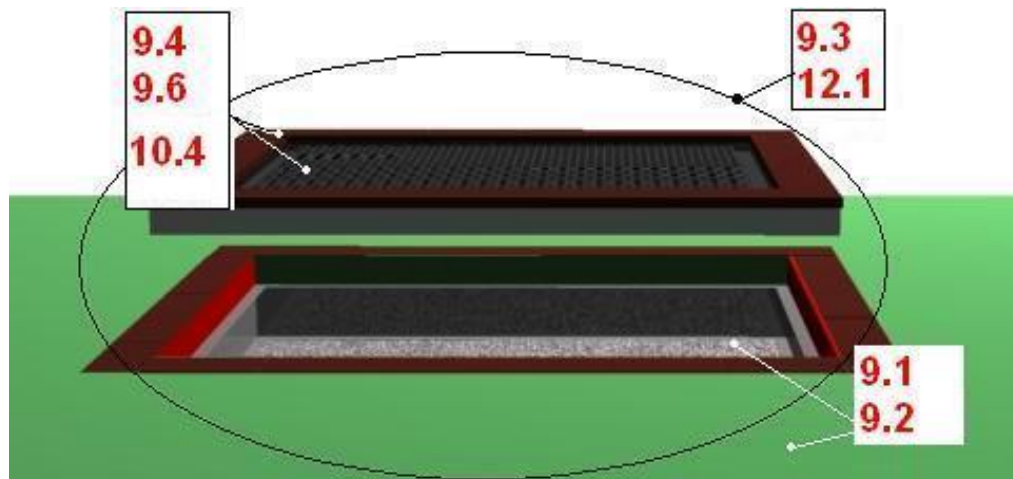
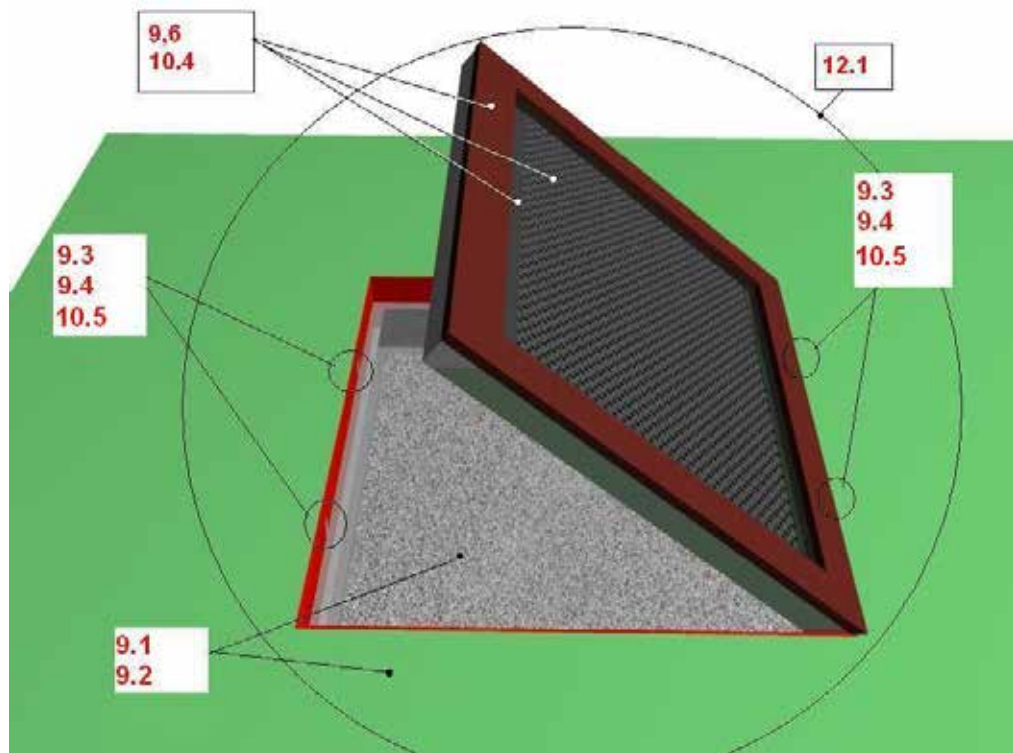

### Monthly maintenance

- Check the spaces between the equipment and the ground (clearance and height of fall).
- Check the ground surface in the area with fall protection for hard objects and loose foundations.

---

Check all connecting elements and fittings for wear and tear and tighten if necessary.  
Replace damaged or missing parts.

Check that moving metal parts (joints, springs, etc.) move smoothly and are not worn.  
Replace if necessary. It is not necessary to lubricate joints as we only use maintenance-free metal roller bearings.

Check all attachments such as chains, ropes, nets, etc. for damage and replace if necessary.

Check rubber parts, sleeves, etc. for wear and tear or damage and replace if necessary.

If necessary, remove excess padding material from the post footings due to danger of rotting.

Check the surface of wooden parts for damage caused by the weather or external influences and mould. Repair or replace if necessary.

Check the surface of plastic and metal parts, e.g. slides, for damage and replace if necessary.

#### **Quarterly maintenance**

Detailed inspection of the operation and stability of the equipment paying particular attention to any wear and tear.

Tighten all forms of attachment.

Repaint and retreat surfaces.

Maintenance of fall protection surfaces.

Lubrication of joints.

Check the height of the fall and top up with loose filler if necessary. If the posts are labelled, top up as far as the mark.

Retighten all bolts





## Annual Maintenance

---

### Annual maintenance

Ascertaining that the equipment, foundations and surfaces are safe for operation.

In particular, the equipment should be checked for decay and corrosion. It may be necessary to dig out or excavate certain components in order to do so. Zinc paint should be applied to corroded areas and scratches.

Stability (check posts, bracing, foundations, etc.).

Ascertaining whether there are any changes in equipment safety as a result of repairs that have been carried out or components that have been added or replaced.



The equipment must be inspected by someone **with the necessary expertise** in strict compliance with the instructions issued by SPOGG Sportgüter GmbH

**A copy of the inspection record should be given to the operator, who must confirm receipt.**

---

Name of item: Trampoline 2000 to set in concrete \_\_\_\_\_ / Art. No. 20.02.125 \_\_\_\_\_  
 Location: \_\_\_\_\_  
 Customer or operator: \_\_\_\_\_  
 (Town, Town council, Kindergarten)

Date of inspection	Inspector	O.K.	Accessible	Barrièred	Defects	Re-paired by	Date

KÜBLER SPORT GMBH | SERVICE

-  
-  

---

**2 Hand over document**

---



**Attention**

After the installation of the equipment pass the installation and maintenance documents to the operator. The operator has to receive the hand over documents. The complete filled and signed hand over document should be sent to the supplier.

Art.-No.: 20.02.125 + 20.02.123 or 20.02.128

Type of item: Trampoline 2000, with installation frame

Serial number: \_\_\_\_\_

**Customer or operator (Town, Town council, Kindergarten, etc.):**

\_\_\_\_\_  
\_\_\_\_\_

Competent person in charge:

\_\_\_\_\_  
\_\_\_\_\_

**Installation company (address):**

\_\_\_\_\_  
\_\_\_\_\_

Responsible assistant (assembler):

\_\_\_\_\_  
\_\_\_\_\_

Received the complete assembly instructions, maintenance instructions and maintenance printout .

\_\_\_\_\_  
(Signature of operator)  
(Stamp)

(Signature of installation company)

Date: \_\_\_\_\_