

*PLIP.7*

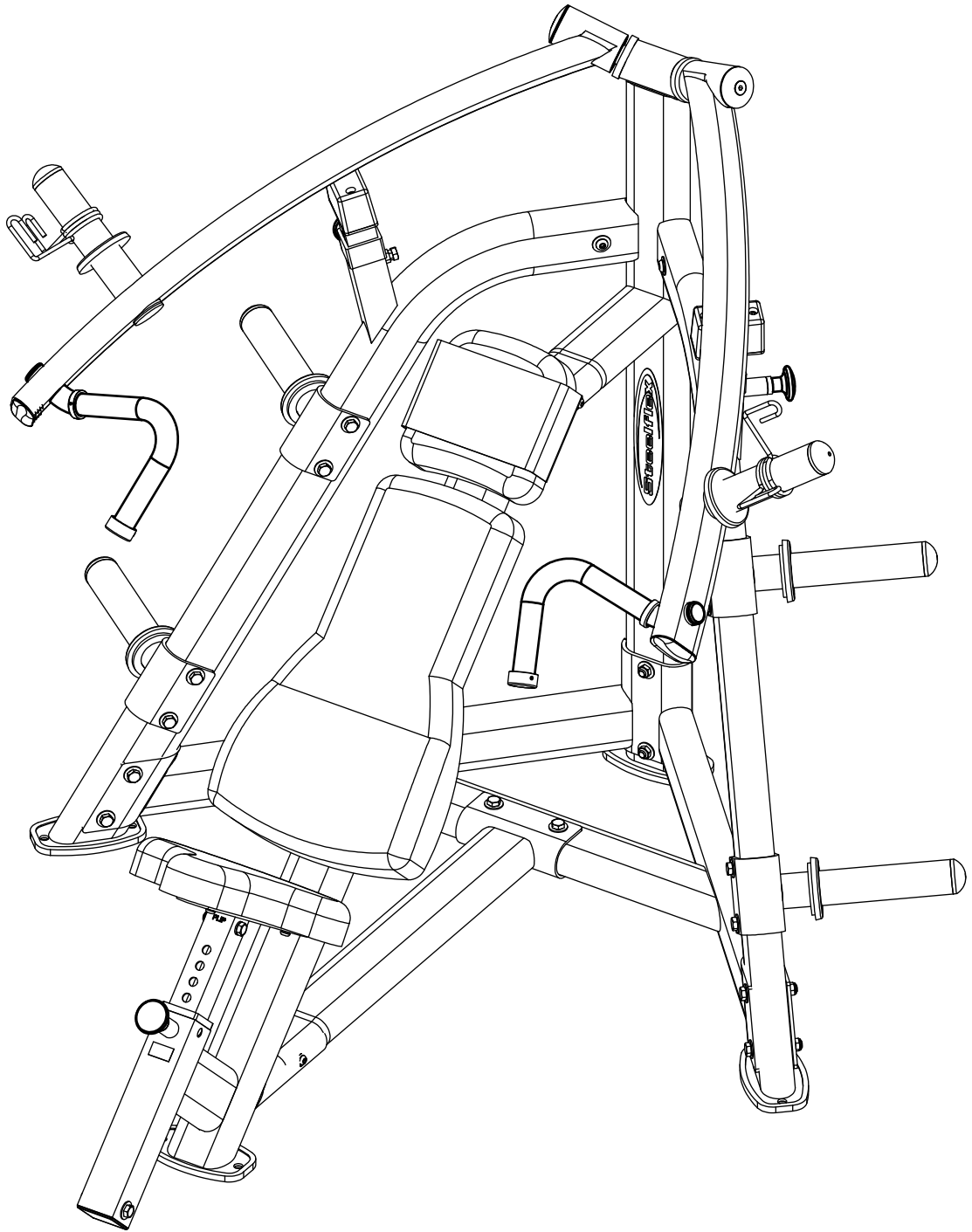

Assembly & Instructions  
**OWNER'S & MANUAL**

# PLIP.7 HARDWARE

(shown in actual size)

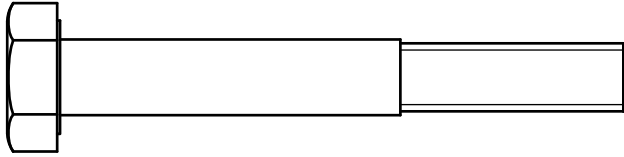
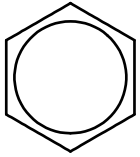

A1. M10x75 HEX HEAD SCREW...9PCS

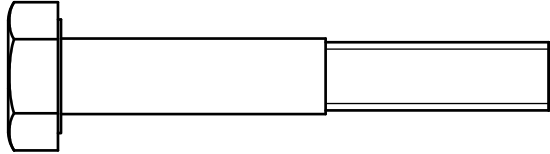
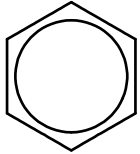

A2. M10x65 HEX HEAD SCREW...9PCS

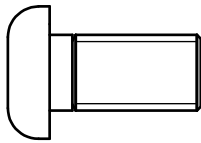
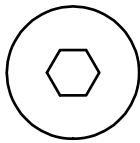

A3. M10x20 ALLEN SCREW(FULL THREAD)...4PCS

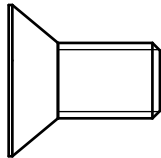
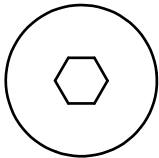

A4. M10x20 TAPER SCREW(FULL THREAD)...2PCS

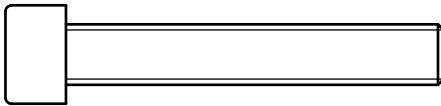
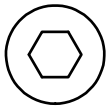

A5. M8x50 SOCKET SCREW(FULL THREAD)...4PCS

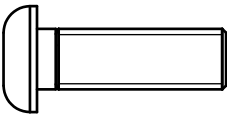
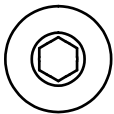

A6. M8x25 ALLEN SCREW(FULL THREAD)...9PCS

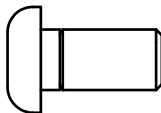
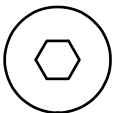

A7. M8x16 ALLEN SCREW(FULL THREAD)...8PCS

mm

0 10 20 30 40 50 60 70 80 90 100 110 120 130 140 150

inch

0 1" 2" 3" 4" 5" 6"

# PLIP.7 HARDWARE

(shown in actual size)

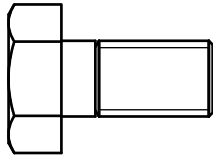
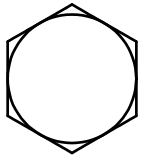

A8. M10x20 HEX HEAD SCREW...2PCS (Pre-installed)



A9. M5x5 GRUB SCREW...8PCS (Pre-installed)

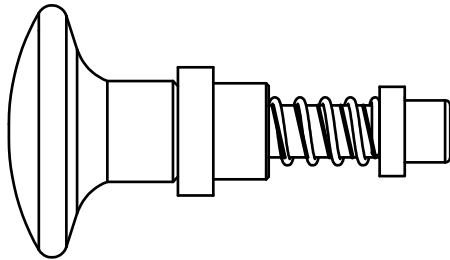
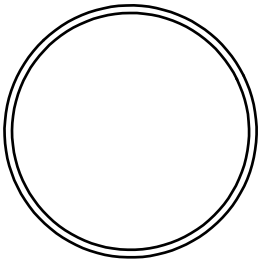

A10. 1/2"x87.5L POP PIN (8250-124G)...2PCS (Pre-installed)

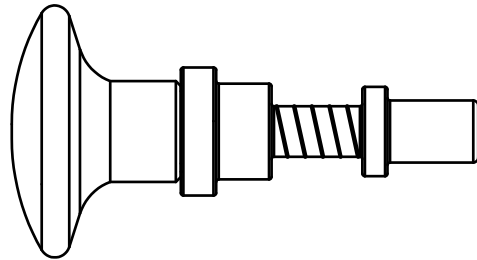
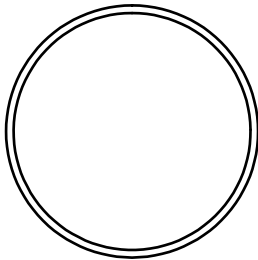

A11. 1/2"x92.5L POP PIN (8250-065G)...1PCS (Pre-installed)

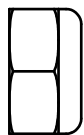
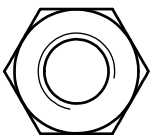

B1. M10 NYLON LOCK NUT...10PCS

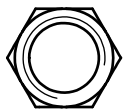

B2. M10 LOCK NUT(5t)...2PCS (Pre-installed)

mm

0 10 20 30 40 50 60 70 80 90 100 110 120 130 140 150

inch

0 1" 2" 3" 4" 5" 6"

# PLIP.7 HARDWARE

(shown in actual size)

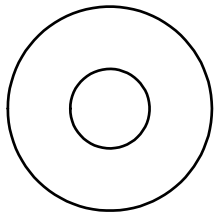

C2. M10 WASHER(Ø27)...30PCS(Pre-installed 2PCS)

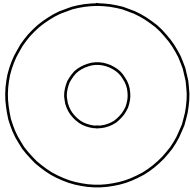

C4. M8 WASHER...13PCS



C5. M8 SPRING WASHER...9PCS

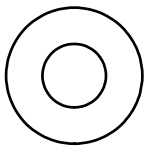

C6. M8 CURVED WASHER...4PCS

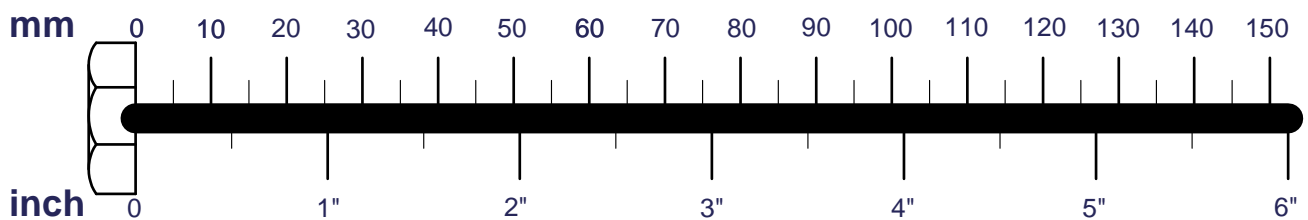

# PLIP.7 PARTS

A [1PCS]

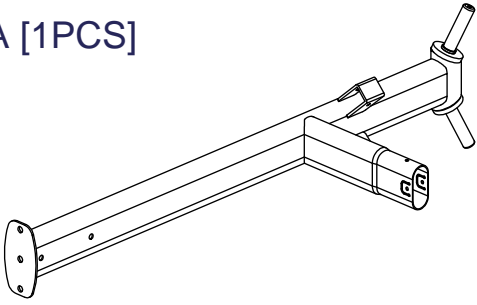

B [1PCS]

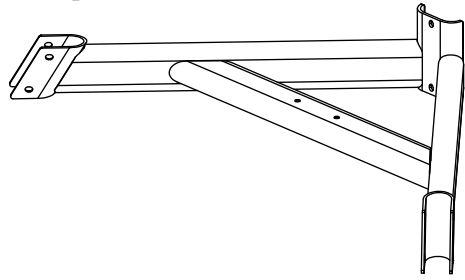

C [1PCS]

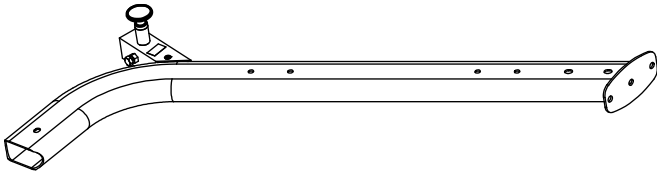

D [1PCS]

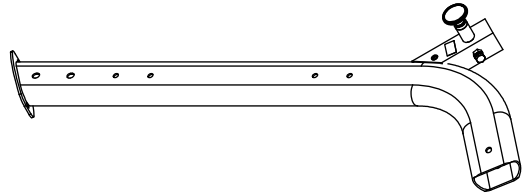

E [1PCS]

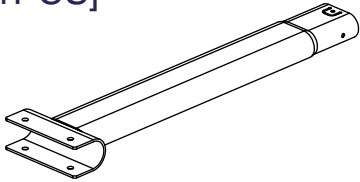

G [1PCS]

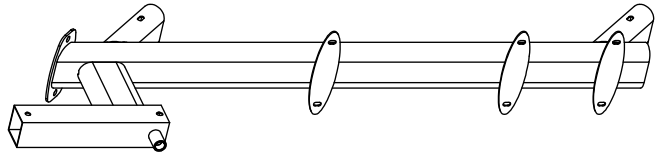

H [1PCS]

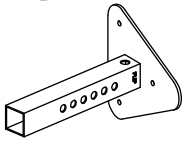

J [1PCS]

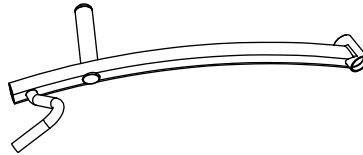

P [1PCS]  
8323-234

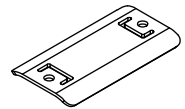

K [1PCS]

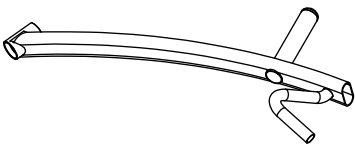

L [4PCS]  
6730001

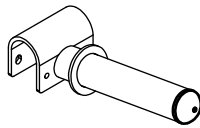

M [2PCS]  
6730003



Q [1PCS]  
9111072

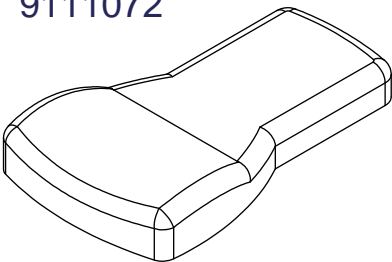

R [1PCS]  
9131025



S [1PCS]  
9144016



T [1PCS]  
8830023  
(pre-installed)



U [1PCS]  
9119010

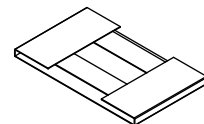
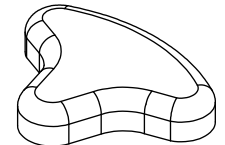
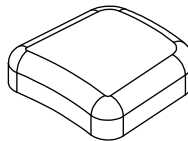

## PLIP.7 PARTS

D1. End Closure (8130-248) .....	[2PCS]
D2. Compression Spring (8840-059) .....	[2PCS]
D3. Ø50 End Cap (9211-020) .....	[2PCS]
D4. Nylon Bushing (9211-030) .....	[2PCS]
D6. 40x80 End Cap (9211-192) .....	[2PCS]
D7. 50x100 END CAP (9211-193) .....	[1PCS]
D8. Rubber Dount (9310-016) .....	[6PCS]
D9. Rubber Insert (9310-076) .....	[4PCS]
D10. Block Rubber (9310-077) .....	[2PCS]
D11. Pinch Cock (OC-06) .....	[2PCS]
D14. Nylon Bushing (9211-047) .....	[1PCS]
D15. 60x60 END CAP (9211-049) .....	[1PCS]
D16. Chrome Collar (8890-048) pre-installed .....	[2PCS]
D17. Bearing (8510-037) pre-installed .....	[4PCS]
D18. Impregnated with handle (9162-149) pre-installed .....	[2PCS]
D19. Pulley spacer (8530-009).....	[2PCS]
D20. End Closure (8130-287)pre-installed.....	[2PCS]
D21. End Cover(9211-169)pre-installed.....	[2PCS]

D1



D2

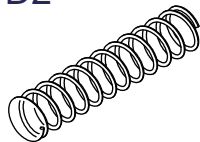

D3



D4

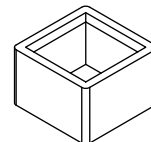

D6

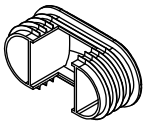

D7

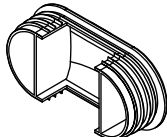

D8

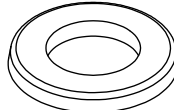

D9

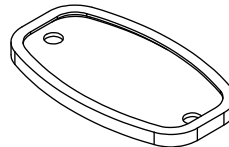

D10

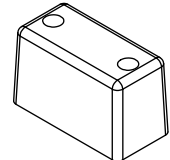

D11

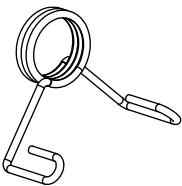

D14

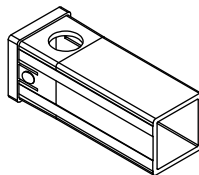

D15

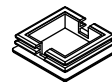

D16



D17



D18

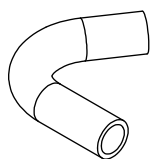

D19



D20



D21



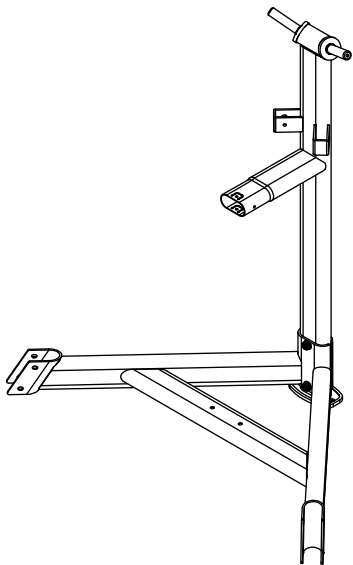

Above shows STEP 1 assembled and completed

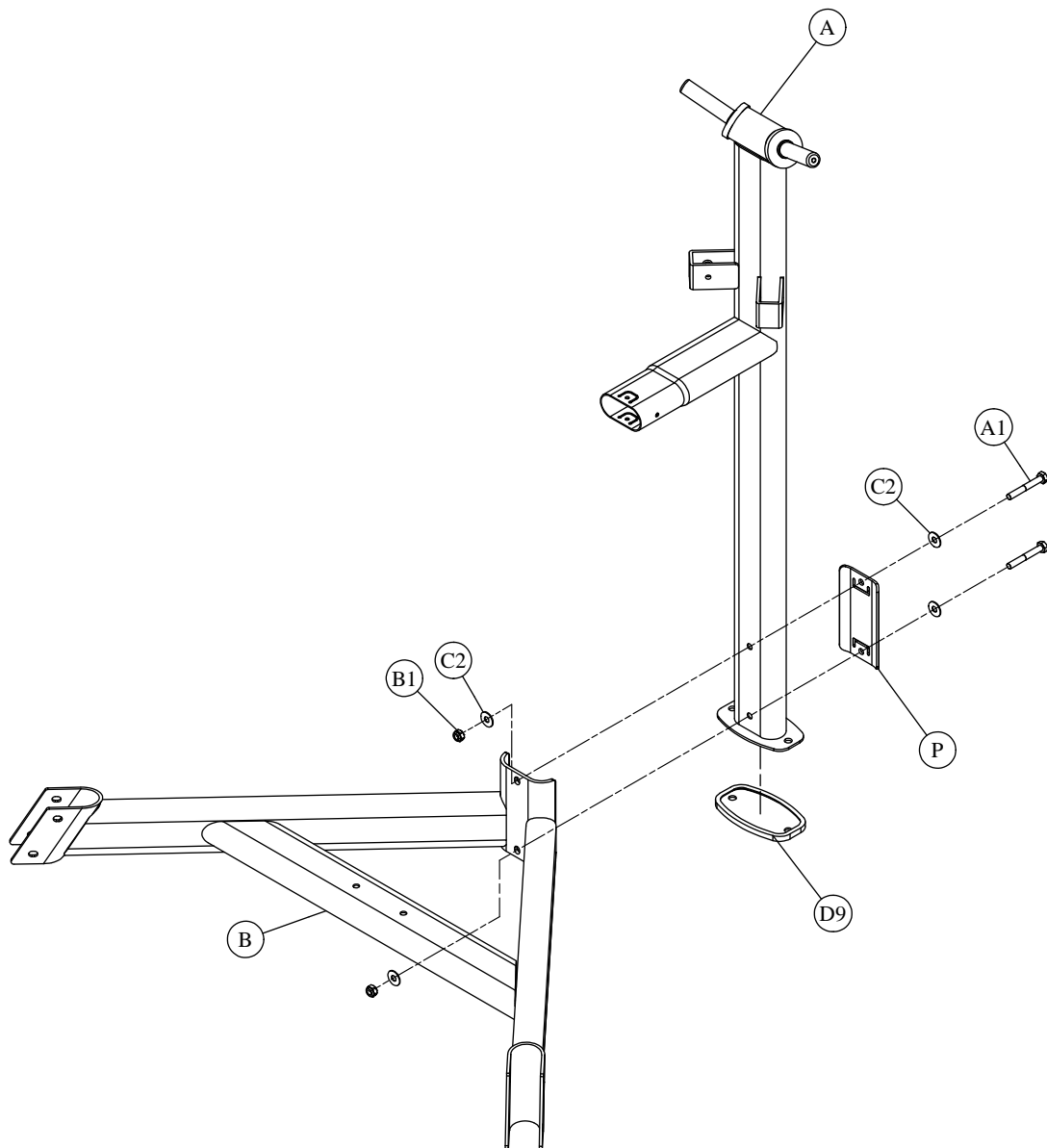

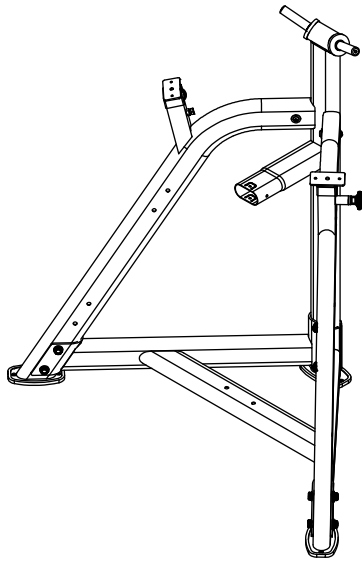

Above shows STEP 2 assembled and completed

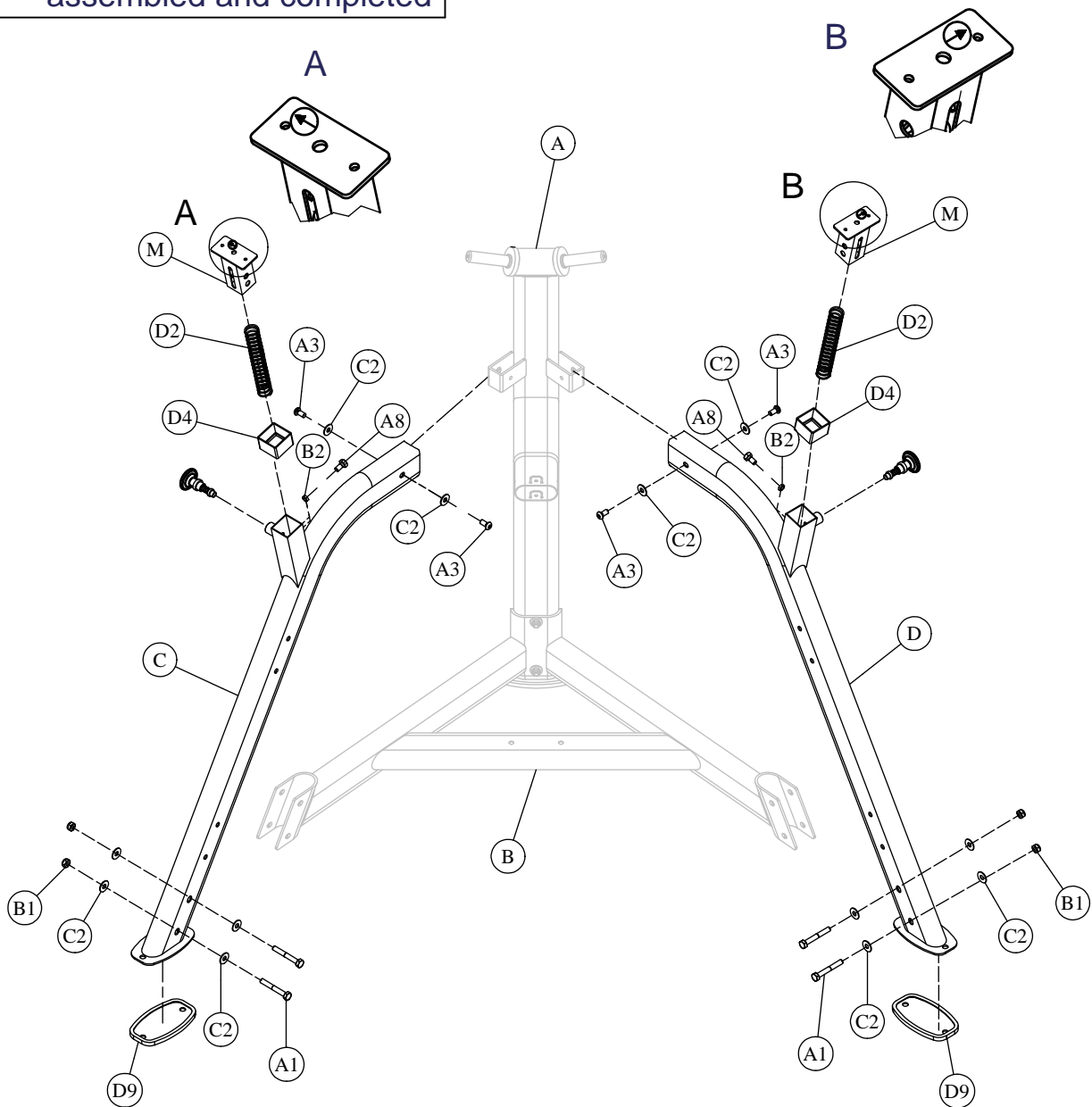



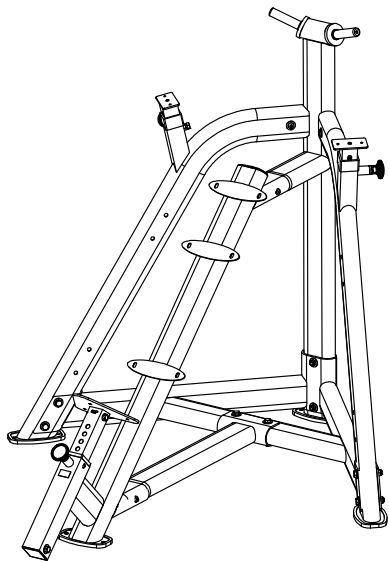

Above shows STEP 3 assembled and completed

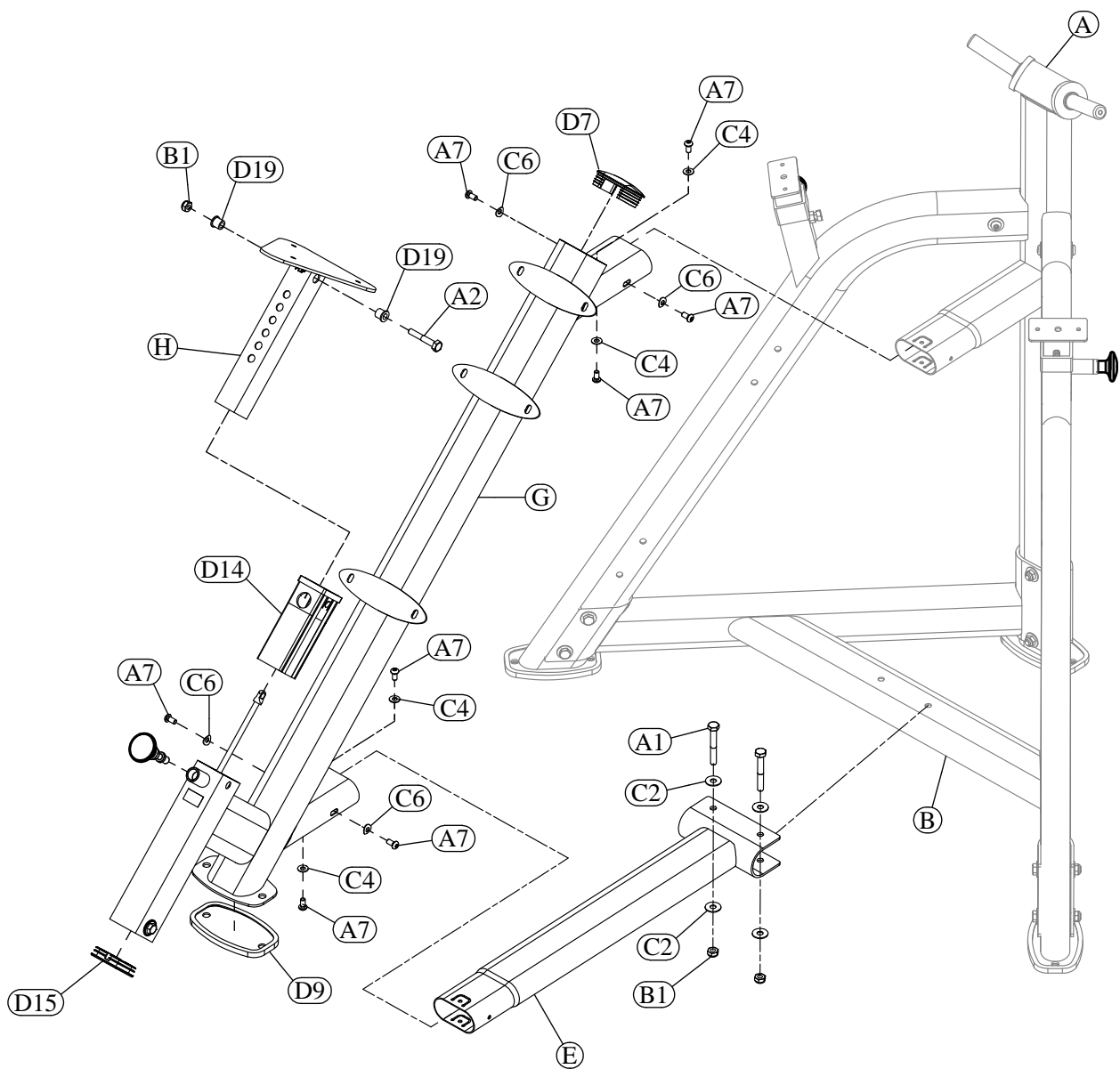

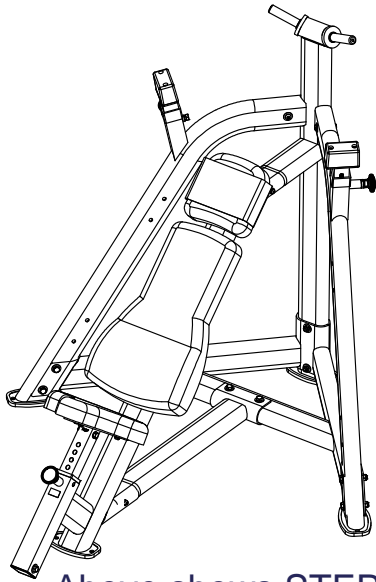

Above shows STEP 4  
assembled and completed

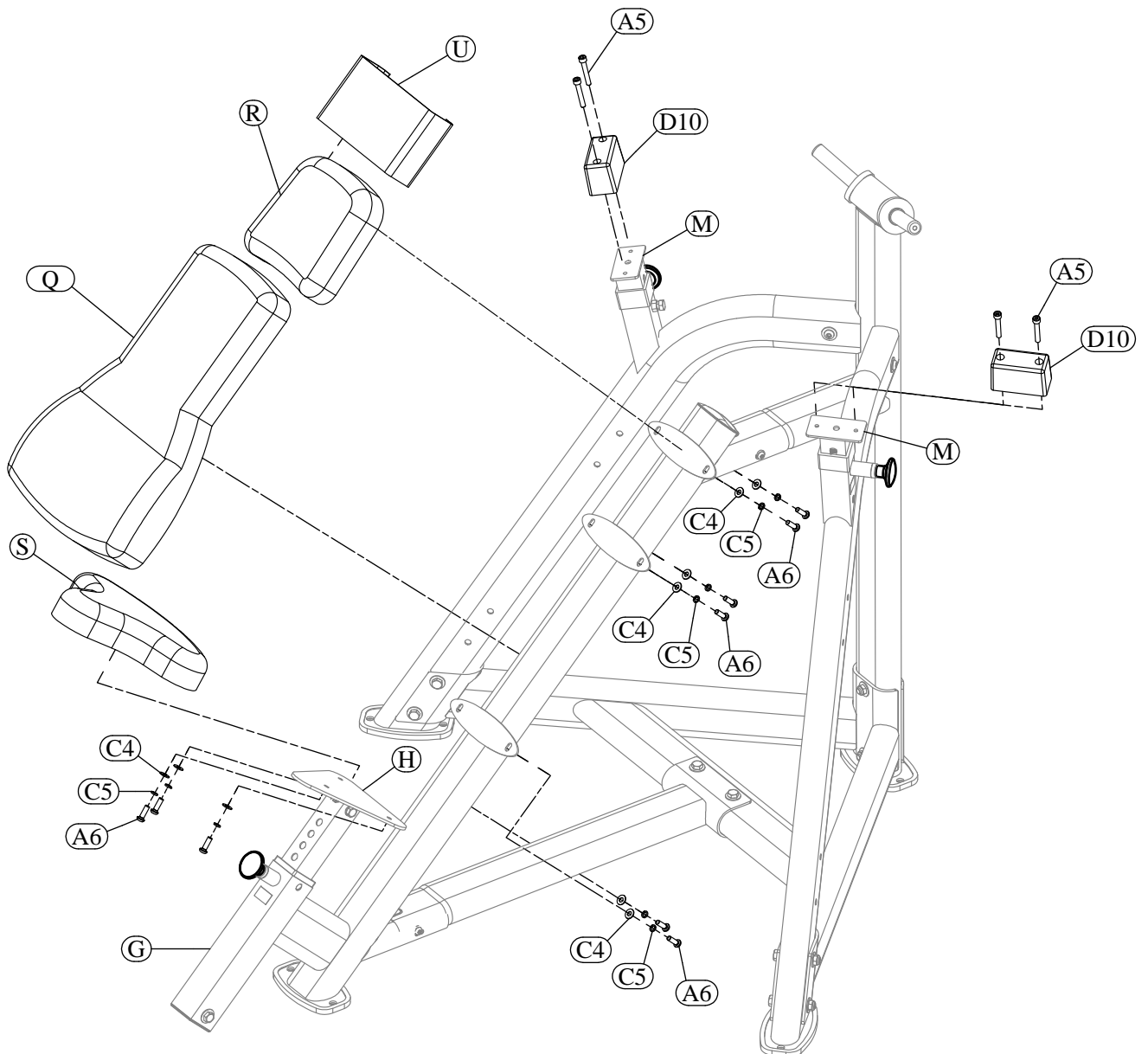

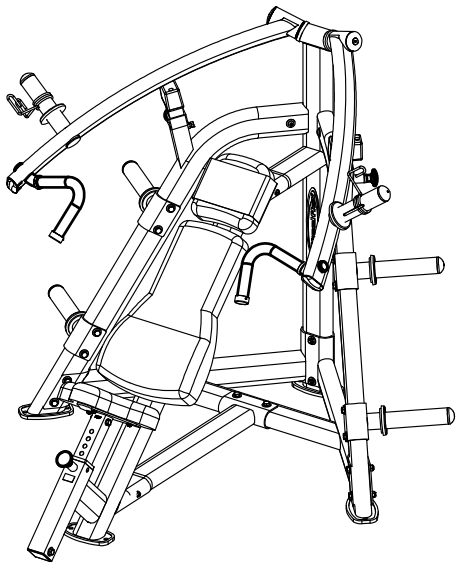

Above shows STEP 5 assembled and completed

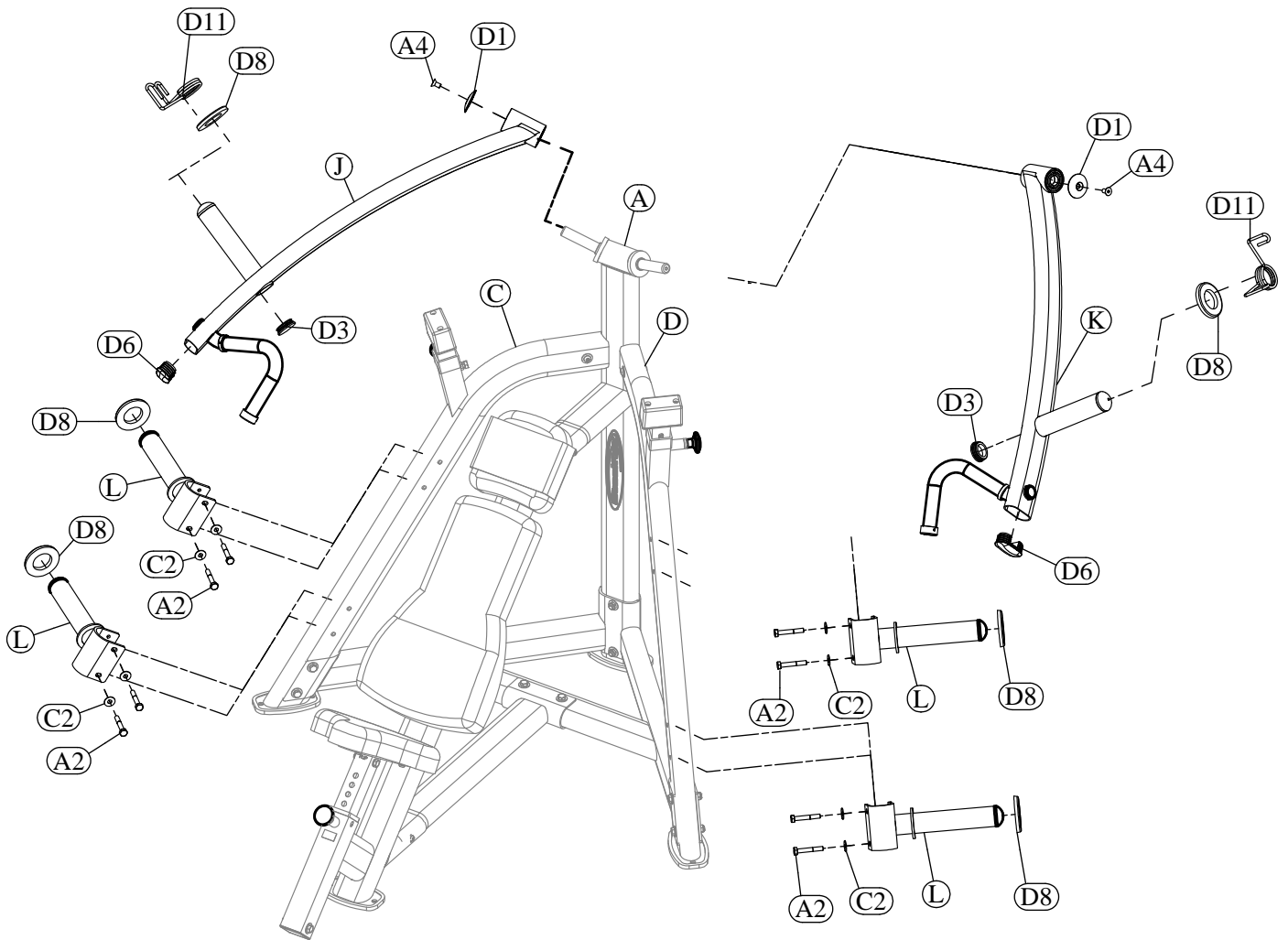

# PLIP.7 Exploded View

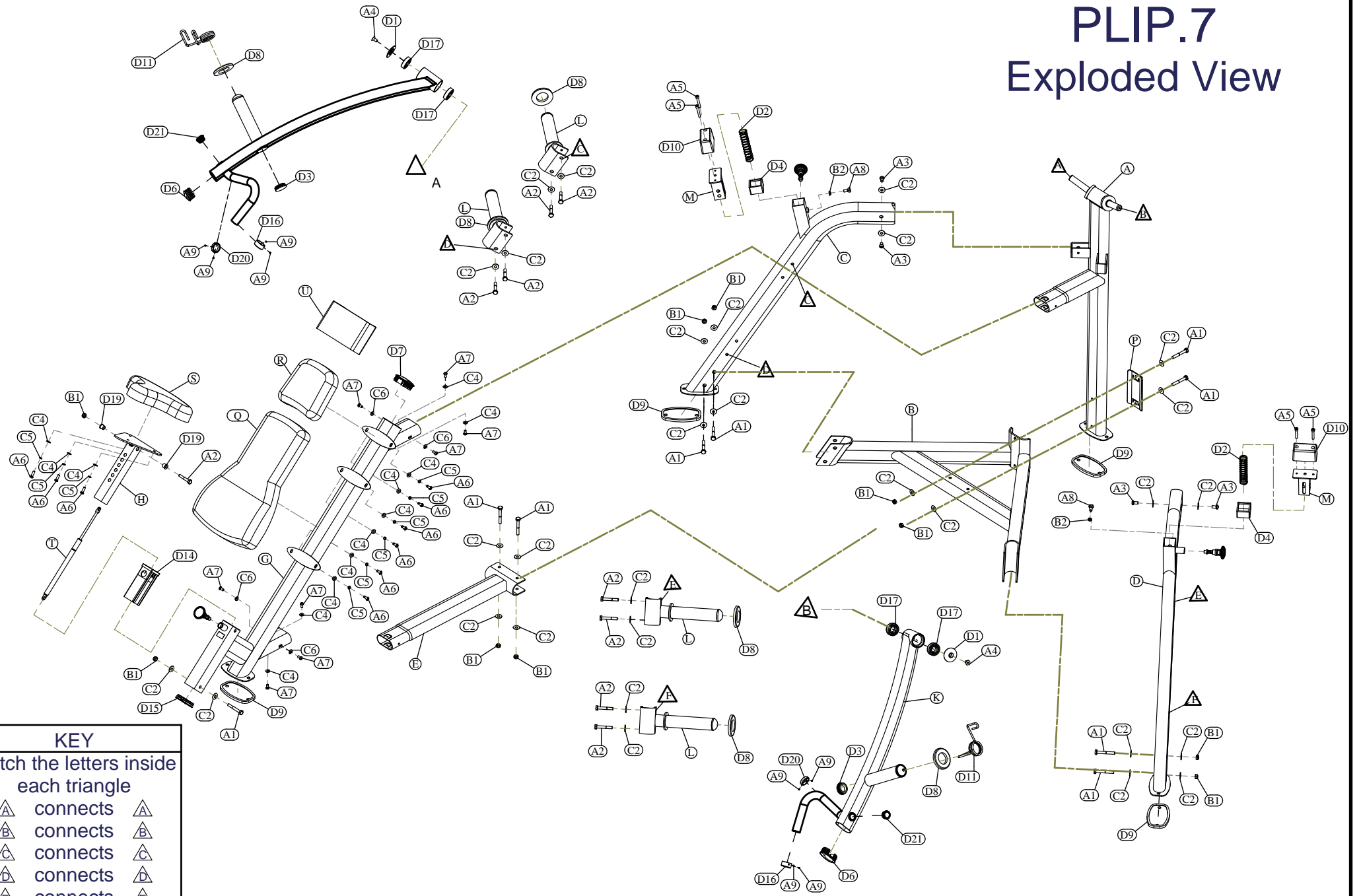

KEY	
Match the letters inside each triangle	
△	connects
△	connects
△	connects
△	connects
△	connects
△	connects